

CE EMC TEST REPORT

for

Product: 7kW AC EV Charger

Model: PAC—CE7002

Report No.: KEYS241105047002EM-02

Issued for

Foshan Putaineng Charging Equipment Co., Ltd
206, Building 1, Baozhi Park, No. 15 Fu'an Avenue, Liandu Village, Leliu Street,
Shunde District, Foshan, Guangdong, China

Issued by

Guangdong KEYS Testing Technology Co., Ltd.
Building 1, No.18, Shihuan Road, Dongcheng Subdistrict, Dongguan, Guangdong,
China
No.4, Fumin Street, Shilong, Dongguan, Guangdong, China

Note: This report shall not be reproduced except in full, without the written approval of Guangdong KEYS Testing Technology Co., Ltd. This document may be altered or revised by Guangdong KEYS Testing Technology Co., Ltd. personnel only, and shall be noted in the revision section of the document. The test results presented in this report only relate to the tested sample.



TABLE OF CONTENTS

1. TEST CERTIFICATION	3
2. TEST SUMMARY	4
3. TEST SITE	5
3.1. TEST FACILITY	5
3.2. MEASUREMENT UNCERTAINTY	5
3.3. LIST OF TEST AND MEASUREMENT INSTRUMENTS	5
4. EUT DESCRIPTION	9
5. TEST METHODOLOGY	10
5.1. TEST MODE	10
5.2. EUT SYSTEM OPERATION	10
6. SETUP OF EQUIPMENT UNDER TEST	11
6.1. DESCRIPTION OF SUPPORT UNITS	11
6.2. CONFIGURATION OF SYSTEM UNDER TEST	11
7. EMISSION TEST	12
7.1. Emission in the Frequency Range up to 30 MHz	12
7.2. RADIATED EMISSION MEASUREMENT(30MHz-1000MHz)	17
7.3. RADIATED EMISSION MEASUREMENT (1000MHz-6000MHz)	21
7.4. HARMONICS CURRENT MEASUREMENT	25
7.5. VOLTAGE FLUCTUATION AND FLICKS MEASUREMENT	33
8. IMMUNITY TEST	35
8.1. GENERAL DESCRIPTION	35
8.2. GENERAL PERFORMANCE CRITERIA DESCRIPTION	37
8.3. ELECTROSTATIC DISCHARGE (ESD)	38
8.4. RADIATED, RADIO-FREQUENCY, ELECTROMAGNETIC FIELD (RS)	42
8.5. ELECTRICAL FAST TRANSIENT (EFT)	45
8.6. SURGE IMMUNITY TEST	47
8.7. CONDUCTED RADIO FREQUENCY DISTURBANCES (CS)	49
8.8. POWER FREQUENCY MAGNETIC FIELD	51
8.9. VOLTAGE DIP & VOLTAGE INTERRUPTIONS	54
9. PHOTOGRAPHS OF THE TEST CONFIGURATION	56
10. PHOTOGRAPHS OF EUT	57

1. TEST CERTIFICATION

Product:	7kW AC EV Charger
Trade mark	N/A
Model:	PAC—CE7002
Applicant :	Foshan Putaineng Charging Equipment Co., Ltd
Address:	206, Building 1, Baozhi Park, No. 15 Fu'an Avenue, Liandu Village, Leliu Street, Shunde District, Foshan, Guangdong, China
Manufacturer:	Foshan Putaineng Charging Equipment Co., Ltd
Address:	206, Building 1, Baozhi Park, No. 15 Fu'an Avenue, Liandu Village, Leliu Street, Shunde District, Foshan, Guangdong, China
Test Date:	November 06, 2024 to November 11, 2024
Issued Date:	November 11, 2024
Power supply:	AC220V, 50/60Hz, 32A, 7kW
Applicable Standards:	EMC Directive 2014/30/EU EN IEC61851-21-2:2021

The above equipment has been tested by Guangdong KEYS Testing Technology Co., Ltd. and found compliance with the requirements in the technical standards mentioned above. The test results presented in this report only relate to the product/system tested. The Other similar equipment will not necessarily produce the same results due to production tolerance and measurement uncertainties.

Test Engineer:

Linda Chen / Engineer

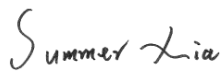

Technical Manager:

Summer Xia / Manager

2. TEST SUMMARY

Item	Result	Remarks
Conducted emission (Mains Port)	PASS	Meet Class B limit
Radiated emission	PASS	Meet Class B limit
Harmonic current emissions	PASS	Complied with limit
Voltage fluctuations & flicker	PASS	Complied with limit

Item	Result	Remarks
ESD	PASS	Complied with the requirements
RS	PASS	Complied with the requirements
EFT	PASS	Complied with the requirements
Surge	PASS	Complied with the requirements
CS	PASS	Complied with the requirements
PFMF	PASS	Complied with the requirements
Voltage dips & voltage variations	PASS	Complied with the requirements

Note: 1) The test result verdict is decided by the limit of test standard.

2) The information of measurement uncertainty is available upon the customer's request.

3. TEST SITE

3.1. TEST FACILITY

Guangdong KEYS Testing Technology Co., Ltd.

Address: Building 1, No.18, Shihuan Road, Dongcheng Subdistrict, Dongguan, Guangdong, China
104, No.4, Fumin Street, Shilong, Dongguan, Guangdong, China

3.2. MEASUREMENT UNCERTAINTY

Parameter	Uncertainty
Temperature	$\pm 1^{\circ} \text{C}$
Humidity	$\pm 5\%$
DC and Low Frequency Voltages	$\pm 3\%$
Conducted Emission(150KHz-30MHz)	$\pm 3.60\text{dB}$
Radiated Emission(30MHz-1GHz)	$\pm 4.76\text{dB}$
Radiated Emission (1GHz-18GHz)	$\pm 4.44\text{dB}$

Note 1: This uncertainty represents an expanded uncertainty expressed at approximately the 95% confidence level using a coverage factor of $k=2$.

3.3. LIST OF TEST AND MEASUREMENT INSTRUMENTS

3.3.1. For conducted emission at the mains terminals test

Name of Equipment	Manufacturer	Model	Serial No.	Calibration Due
EMI Test Receiver	Rohde&Schwarz	ESCI7	KEYS-E-005	July 2, 2025
Pulse limiter	Rohde&Schwarz	ESH3-Z2	KEYS-E-003	July 2, 2025
LISN impedance network TWO-LINE V-WORK	Rohde&Schwarz	ENV216	KEYS-E-004	July 2, 2025
Screened room	AUDIX	6*3*3	KEYS-E-001	July 23, 2025

3.3.2. For radiated emission test (30MHz-1GHz)

Name of Equipment	Manufacturer	Model	Serial No.	Calibration Due
EMI Test Receiver	Rohde&Schwarz	ESCI7	KEYS-E-005	July 2, 2025
Composite antenna	Schwarzbeck	VULB9168	KEYS-E-013	July 9,2025
Preamplifier	AUDIX	EM330	KEYS-E-014	July 2,2025
3m standard semi-anechoic chamber	AUDIX	9*6*6	KEYS-E-002	July 23, 2025

3.3.3. For radiated emission test (1GHz above)

Name of Equipment	Manufacturer	Model	Serial No.	Calibration Due
EMI Test Receiver	Rohde&Schwarz	ESCI7	KEYS-E-005	July 2, 2025
Multiple aerial	Schwarzbeck	9120D	KEYS-E-012	July 9,2025
Preamplifier	AUDIX	EM01G18 G	KEYS-E-015	July 2, 2025
3m standard semi-anechoic chamber	AUDIX	9*6*6	KEYS-E-002	July 23, 2025

3.3.4. For harmonic current emissions and voltage fluctuations/flicker test

Name of Equipment	Manufacturer	Model	Serial No.	Calibration Due
Harmonics / Flicker Test System	DCUU INSTRUMENT CO., LTD.	KDF-11005G	KEYS-E-017	July 2,2025
AC Power Source	DCUU INSTRUMENT CO., LTD.	BADT002-11	KEYS-E-025	July 2,2025

3.3.5. For electrostatic discharge immunity test

Name of Equipment	Manufacturer	Model	Serial No.	Calibration Due
-------------------	--------------	-------	------------	-----------------

ESD Generator	Shanghai Lingshi Electronics Co., LTD	ESD-203A	KEYS-E-023	July 3, 2025
---------------	---------------------------------------	----------	------------	--------------

3.3.6. For radio frequency electromagnetic field immunity (R/S) test (DQT)

Name of Equipment	Manufacturer	Model	Serial No.	Calibration Due
Signal Generator	Agilent	N517113-50B	KEYS-EE-038	Sep. 17, 2025
Amplifier	A&R	150W1000M3	KEYS-EE-039	Sep. 17, 2025
Amplifier	A&R	50SIG6M2	KEYS-EE-040	Sep. 17, 2025
Antenna	SCHWARZBECK	STLP9149	KEYS-EE-046	Sep. 17, 2025
Isotropic Field Probe	A&R	FL7006	KEYS-EE-049	Sep. 17, 2025
Log-periodic Antenna	SCHWARZBECK	STLP 9128E	KEYS-EE-042	Sep. 17, 2025

3.3.7. For electrical fast transient/burst immunity test

Name of Equipment	Manufacturer	Model	Serial No.	Calibration Due
EFT Tester	HTEC	HEFT 51	KEYS-EE-051	Sep. 17, 2025
EFT Coupling Clamp	HTEC	HEFT 51-C	KEYS-EE-053	Sep. 17, 2025

3.3.8. For surge immunity test

Name of Equipment	Manufacturer	Model	Serial No.	Calibration Due
Lightning surge generator	Shanghai Prima Electronics Co., LTD	SUG61005TB-221 6	KEYS-E-030	July 2, 2025

3.3.9. For injected currents susceptibility test

Name of Equipment	Manufacturer	Model	Serial No.	Calibration Due
C/S Test System	SCHLODER	CDG-6000-25	KEYS-EE-056	Sep. 17, 2025

Coupling Decoupling Network	SCHLODER	CDN-M2+3	KEYS-EE-059	Sep. 17, 2025
Electromagnetic Injection Clamp	Luthi	EM101	KEYS-EE-066	Sep. 17, 2025

3.3.10. For power frequency magnetic field immunity test

Name of Equipment	Manufacturer	Model	Serial No.	Calibration Due
Magnetic Field Tester	HTEC	HPFMF	KEYS-EE-067	Sep. 17, 2025

3.3.11. For voltage dips and short interruptions immunity test

Name of Equipment	Manufacturer	Model	Serial No.	Calibration Due
Dips Tester	HTEC	HPFS	KEYS-EE-078	Sep. 17, 2025

4. EUT DESCRIPTION

Product	7kW AC EV Charger
Model	PAC—CE7002
Supplied Voltage	AC220V, 50/60Hz, 32A
Power	7kW

I/O PORT

I/O PORT TYPES	Q'TY	TESTED WITH
AC Port	1	<input checked="" type="checkbox"/>
DC Port	1	<input type="checkbox"/>

Models Difference

N/A



5. TEST METHODOLOGY

5.1. TEST MODE

The EUT was tested together with the thereafter additional components, and a configuration, which produced the worst emission levels, was selected and recorded in this report.

The following test mode(s) were assessed.

	Test Items	Test Mode
Emission	Conducted Emission	Full Load
	Radiated Emission	Full Load
	Harmonic current emissions	Full Load
	Voltage fluctuations & flicker	Full Load
Immunity	ESD	Full Load
	RS	Full Load
	EFT	Full Load
	Surge	Full Load
	C/S	Full Load
	M/S	Full Load
	Dips	Full Load

5.2. EUT SYSTEM OPERATION

1. Set up EUT with the support equipment.
2. Make sure the EUT work normally during the test.

6. SETUP OF EQUIPMENT UNDER TEST

6.1. DESCRIPTION OF SUPPORT UNITS

The EUT has been tested as an independent unit together with other necessary accessories or support units. The following support units or accessories were used to form a representative test configuration during the tests.

No.	Equipment	Model	Serial No.	FCC ID	Trade Name	Data Cable	Power Cord
1.	N/A	N/A	N/A	N/A	N/A	N/A	N/A

Note: 1) All the equipment/cables were placed in the worst-case configuration to maximize the emission during the test.

2) Grounding was established in accordance with the manufacturer’s requirements and conditions for the intended use.

6.2. CONFIGURATION OF SYSTEM UNDER TEST

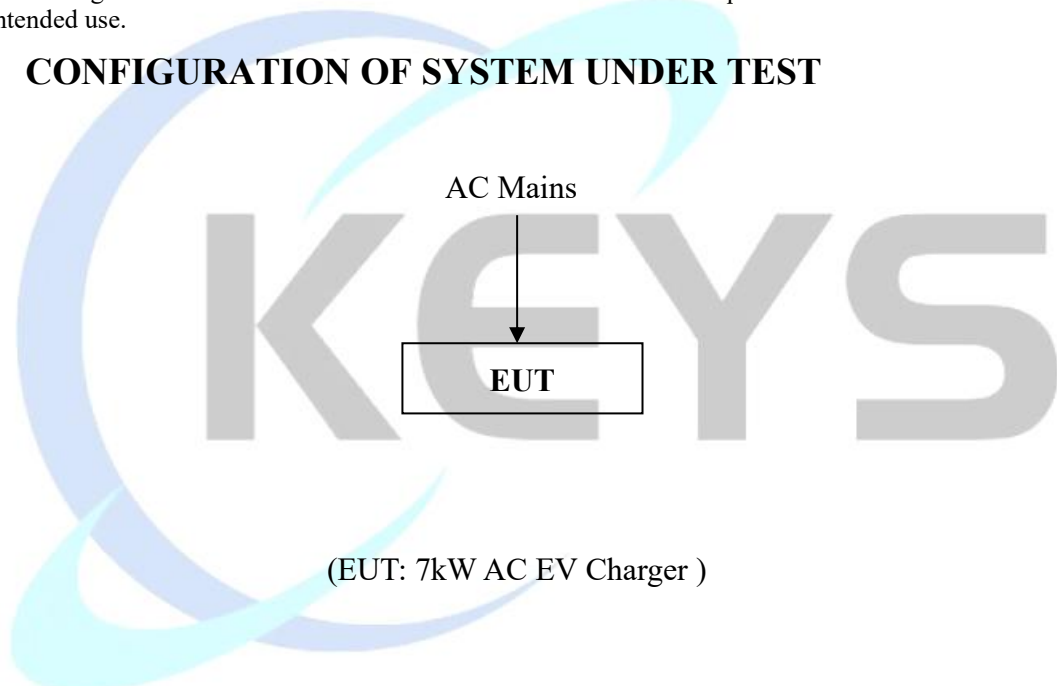

(EUT: 7kW AC EV Charger)

7. EMISSION TEST

7.1. Emission in the Frequency Range up to 30 MHz

7.1.1. LIMITS

Table 7 – Disturbance voltage limits for class A equipment for AC power input port

Frequency range MHz	Rated power of ≤ 20 kVA		Rated power of > 20 kVA ^{a)}		High power electronic systems and equipment, rated power of > 75 kVA ^{b)}	
	Quasi-peak dB(μV)	Average dB(μV)	Quasi-peak dB(μV)	Average dB(μV)	Quasi-peak dB(μV)	Average dB(μV)
0,15 to 0,50	79	66	100	90	130	120
0,50 to 5	73	60	86	76	125	115
			90	80		
5 to 30	73	60	decreasing linearly with logarithm of frequency to		115	105
			73	60		

Table 8 – Disturbance voltage limits for class B equipment for AC power input port

Frequency range MHz	Quasi-peak dB(μV)	Average dB(μV)
0,15 to 0,50	66 decreasing linearly with logarithm of frequency to 56	56 decreasing linearly with logarithm of frequency to 46
0,50 to 5	56	46
5 to 30	60	50

Note: 1) The lower limit shall apply at the transition frequencies.

2) The limit decreases in line with the logarithm of the frequency in the range of 0.15 to 0.50 MHz.

7.1.2. TEST PROCEDURES

The EUT and Support equipment, if needed, was set up as per the test configuration to simulate typical usage per the user's manual. When the EUT is a tabletop system, a wooden table with a height of 0.8 meters is used and is placed on the ground plane. When the EUT is floor standing equipment, it is placed on the ground plane, which has a 3-12 mm non-conductive covering to insulate the EUT from the ground plane. The EUT should be 0.8 m apart from the AMN, where the mains cable supplied by the manufacturer is longer than 1 m, the excess should be folded at the centre into a bundle no longer than 0.4 m, Details please refer to test setup photography.

The Receiver scanned from 150 kHz to 30 MHz for emissions in each of the test modes.
During the above scans, the emissions were maximized by cable manipulation.

A scan was taken on both of the power lines, Line and neutral, recording at least the six highest emissions. Emission frequency and amplitude were recorded into a computer in which correction factors were used to



Report No.: KEYS241105047002EM-02

calculate the emission level and compare reading to the applicable limit. The test data of the worst-case condition(s) was recorded.

Note: Test Software Name: e3, Software Version: 1.0.0.0.



7.1.3. TEST SETUP

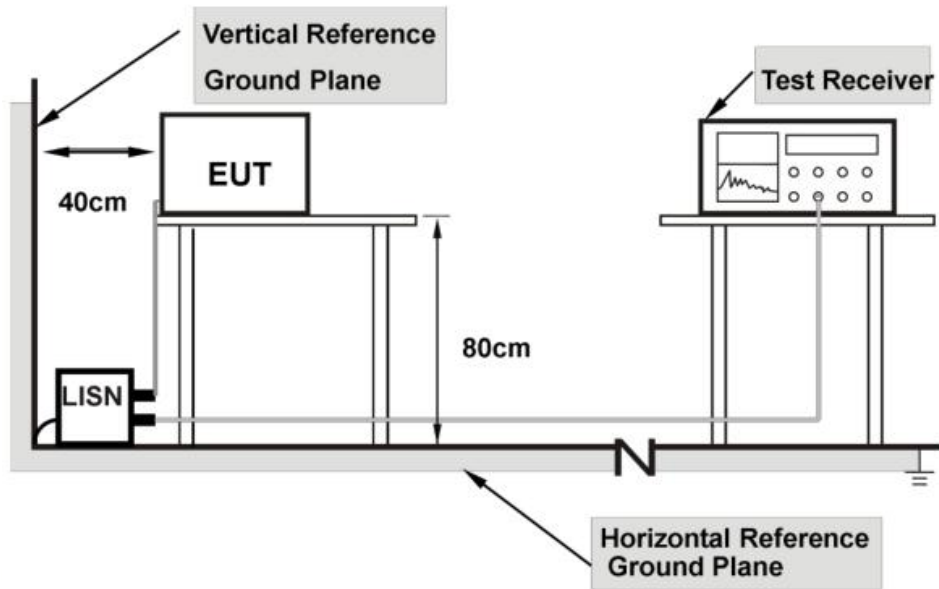

Note: 1.Support units were connected to second LISN.
 2.Both of LISNs(AMN) are 80 cm from EUT and at least 80 from other units and other metal planes

7.1.4. TEST RESULT

Product name	7kW AC EV Charger	Tested By	Brian
Model	PAC—CE7002	Detector Function	Peak / Quasi-peak/AV
Test Mode	Full Load	6 dB Bandwidth	9 kHz
Environmental Conditions	24.1°C, 50 % RH, 101.12 kPa	Test Result	Pass

Note:
 L = Line Line, N = Neutral Line
 Freq. = Emission frequency in MHz
 Reading level (dB V) = Receiver reading
 Corr. Factor (dB) = attenuator + Cable loss
 Level (dB V) = Reading level (dB V) + Corr. Factor (dB)
 Limit (dB V) = Limit stated in standard
 Over Limit (dB) = Level (dB V) – Limit (dB V)
 QP = Quasi-Peak
 AV = Average

The worst measurement data as follows:

Line:

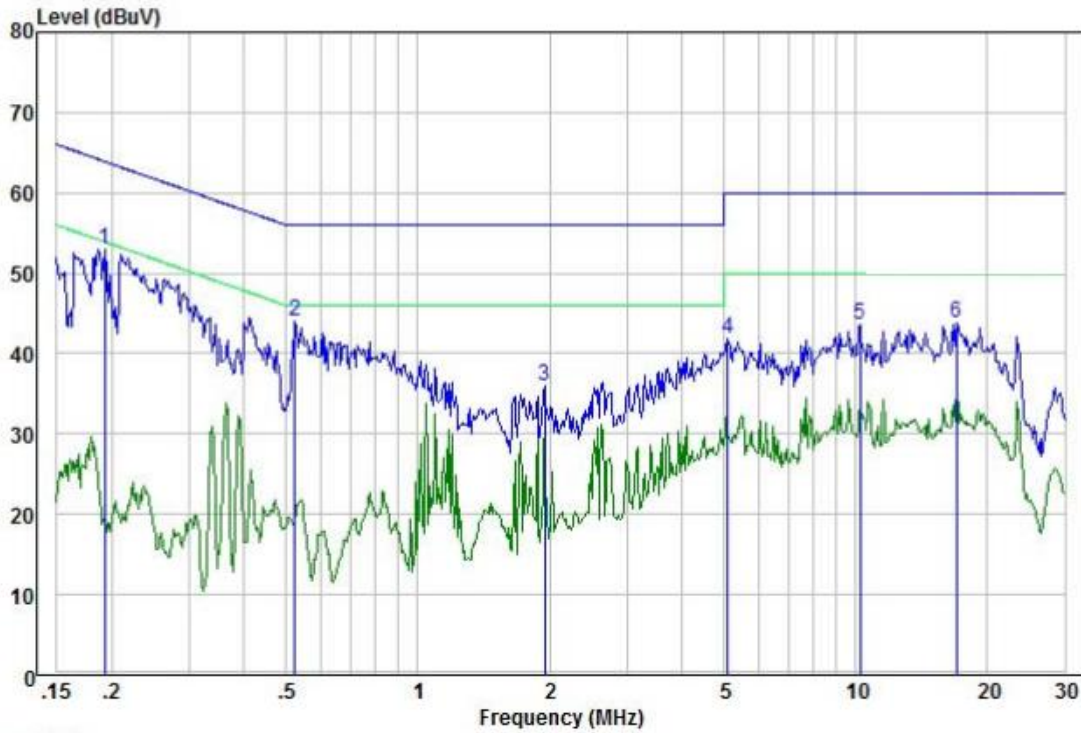

	Freq	Level	Read Level	Factor	Limit Line	Over Limit	LISN Factor	Cable Loss	Remark
	MHz	dBuV	dBuV	dB	dBuV	dB	dB	dB	
1	0.19	52.92	33.32	19.60	63.93	-11.01	9.60	10.00	Peak
2	0.52	44.09	24.50	19.59	56.00	-11.91	9.59	10.00	Peak
3	1.95	36.03	16.53	19.50	56.00	-19.97	9.50	10.00	Peak
4	5.11	41.95	22.41	19.54	60.00	-18.05	9.54	10.00	Peak
5	10.23	43.56	23.85	19.71	60.00	-16.44	9.71	10.00	Peak
6	17.02	43.73	23.70	20.03	60.00	-16.27	10.03	10.00	Peak

Neutral:

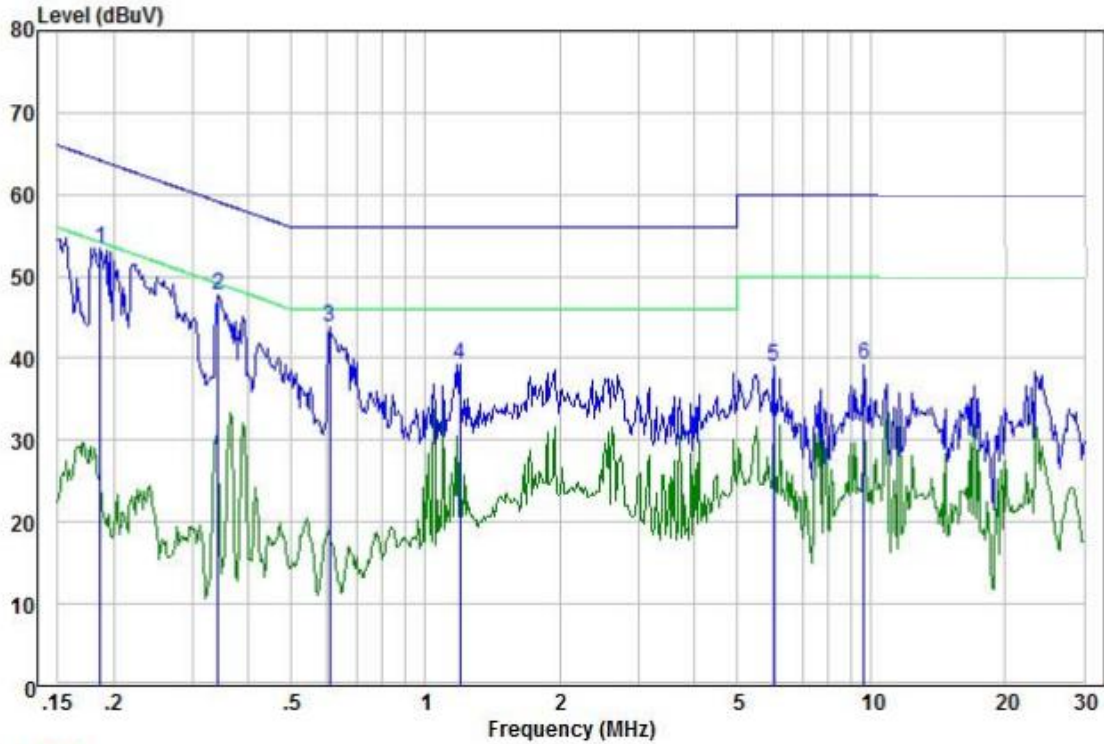

	Freq	Level	Read Level	Factor	Limit Line	Over Limit	LISN Factor	Cable Loss	Remark
	MHz	dBuV	dBuV	dB	dBuV	dB	dB	dB	
1	0.19	53.35	33.85	19.50	64.20	-10.85	9.50	10.00	Peak
2	0.34	47.82	28.32	19.50	59.13	-11.31	9.50	10.00	Peak
3	0.61	43.87	24.37	19.50	56.00	-12.13	9.50	10.00	Peak
4	1.20	39.16	19.76	19.40	56.00	-16.84	9.40	10.00	Peak
5	6.06	39.11	19.46	19.65	60.00	-20.89	9.65	10.00	Peak
6	9.65	39.29	19.50	19.79	60.00	-20.71	9.79	10.00	Peak

Remark:

1. If Provide Multiple voltage, All possible modes of operation were investigated, and testing at two nominal voltages of 230V/50Hz and 110V/60Hz, only the worst case emissions reported.

7.2. RADIATED EMISSION MEASUREMENT(30MHz-1000MHz)

7.2.1. LIMITS

FREQUENCY (MHz)	Class A(At 3m)	Class B(At 3m)
	Quasi-peak dB(V/m)	Quasi-peak dB(V/m)
30 ~ 230	50	40
230 ~ 1000	57	47

Note: 1) The lower limit shall apply at the transition frequencies.

2) Emission level (dB V/m) = 20 log Emission level (V/m).

7.2.2. TEST PROCEDURE

The equipment was set up as per the test configuration to simulate typical usage per the user's manual. When the EUT is a tabletop system, a wooden turntable with a height of 0.8 meters is used which is placed on the ground plane. When the EUT is floor standing equipment, it is placed on the ground plane which has a 0.1 m non-conductive covering to insulate the EUT from the ground plane.

The antenna was placed at 3 meter away from the EUT. The antenna connected to the spectrum analyzer via a cable and at times a pre-amplifier would be used.

The analyzer / receiver quickly scanned from 30 MHz to 1000 MHz. The EUT test program was started. Emissions were scanned and measured rotating the EUT to 360 degrees and positioning the antenna 1 to 4 meters above the ground plane, in both the vertical and the horizontal polarization, to maximize the emission reading level.

During the above scans, the emissions were maximized by cable manipulation. Each modes is measured, recorded at least the six highest emissions. The emission frequency, amplitude, antenna position, polarization and turntable position were recorded into a computer in which correction factors were used to calculate the emission level and compare reading to the applicable limit and only Q.P. reading is presented.

The test data of the worst-case condition(s) was recorded.

Note: Test Software Name: e3, Software Version: 8.2.1.0.

7.2.3. TEST SETUP

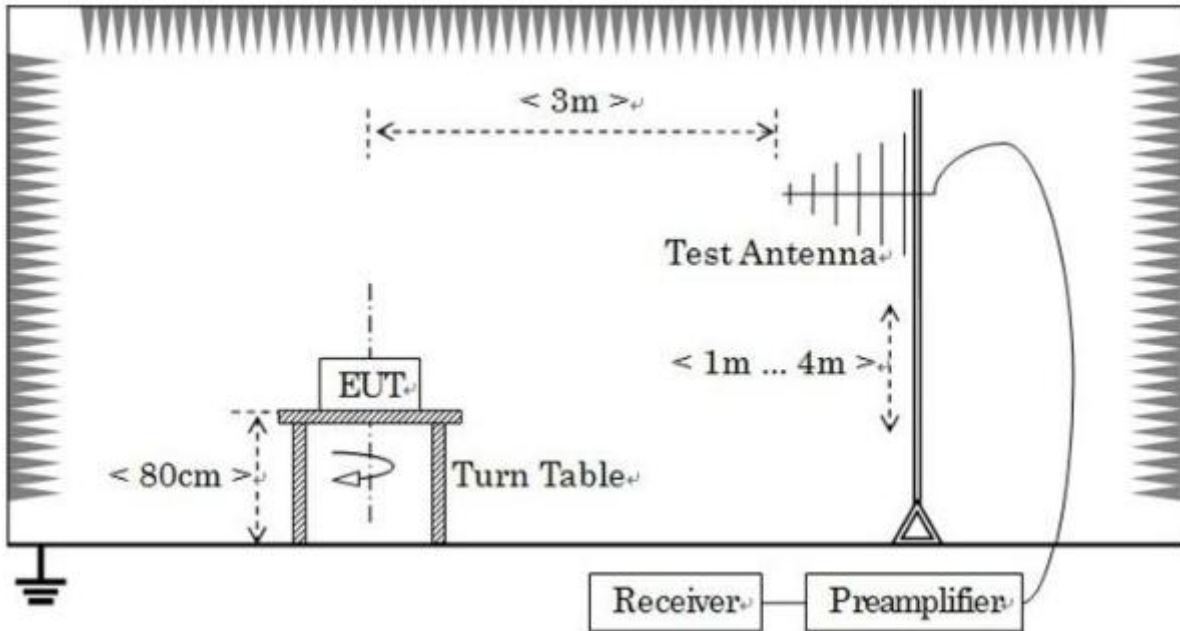

Note: For the actual test configuration, please refer to the related item – Photographs of the Test Configuration

7.2.4. TEST RESULT

Product name	7kW AC EV Charger	Antenna Distance	3 m
Model	PAC—CE7002	Antenna Pole	Vertical / Horizontal
Test Mode	Full Load	Detector Function	Peak / Quasi-peak
Environmental Conditions	24.1 °C, 51 % RH, 101.22 kPa	6 dB Bandwidth	120 kHz
Tested by	Brian	Test Result	Pass

Note:

Freq. = Emission frequency in MHz

Reading level (dB V) = Receiver reading (dB V)

Corr. Factor (dB/m) = Antenna factor (dB/m) + Cable loss (dB) - Preamp Factor (dB)

Measurement (dB V/m) = Reading level (dB V) + Corr. Factor (dB/m)

Limit (dB V/m) = Limit stated in standard

Over Limit (dB) = Measurement (dB V/m) - Limit (dB V/m)

QP = Quasi-Peak

Please refer to the following diagram:

Horizontal:

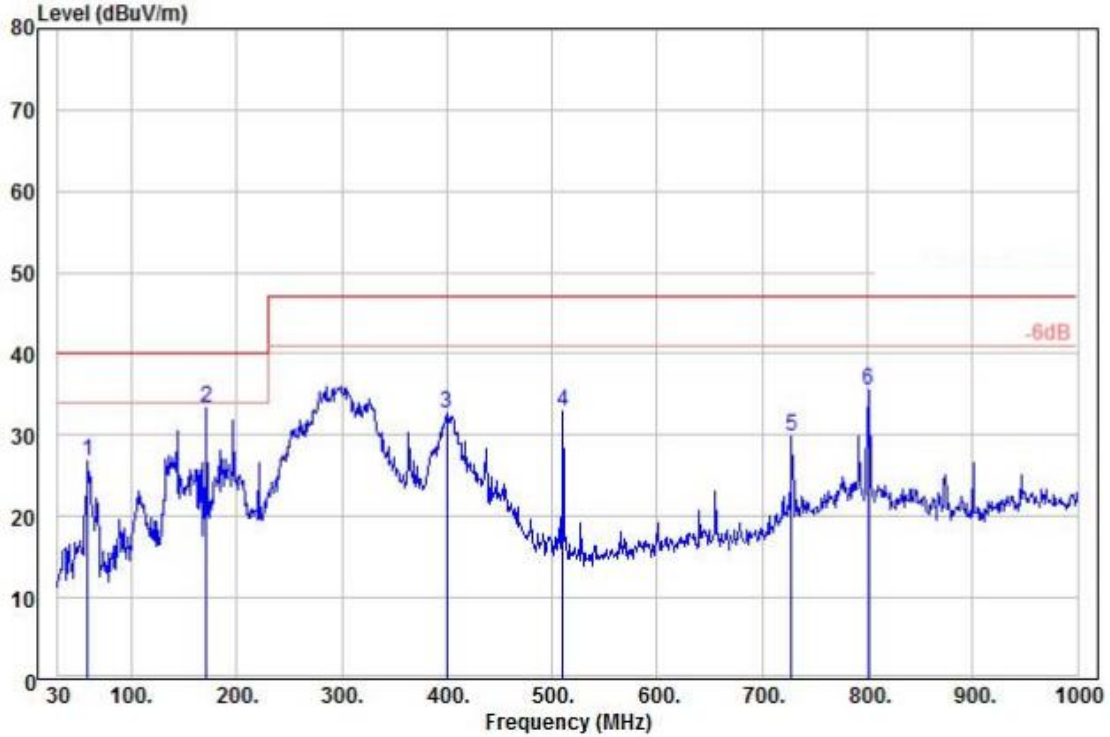

	Freq	Level	Read Level	Factor	Limit Line	Over Limit	Ant Factor	Cable Loss	Remark
	MHz	dBuV/m	dBuV	dB/m	dBuV/m	dB	dB/m	dB	
1	58.13	26.83	44.35	-17.52	40.00	-13.17	12.34	0.60	Peak
2	171.62	33.42	50.68	-17.26	40.00	-6.58	12.29	0.96	Peak
3	399.57	32.78	46.13	-13.35	47.00	-14.22	15.37	1.48	Peak
4	510.15	32.88	43.88	-11.00	47.00	-14.12	17.29	1.69	Peak
5	728.40	29.79	35.62	-5.83	47.00	-17.21	21.74	2.07	Peak
6	801.15	35.60	40.21	-4.61	47.00	-11.40	22.71	2.18	Peak

Vertical:

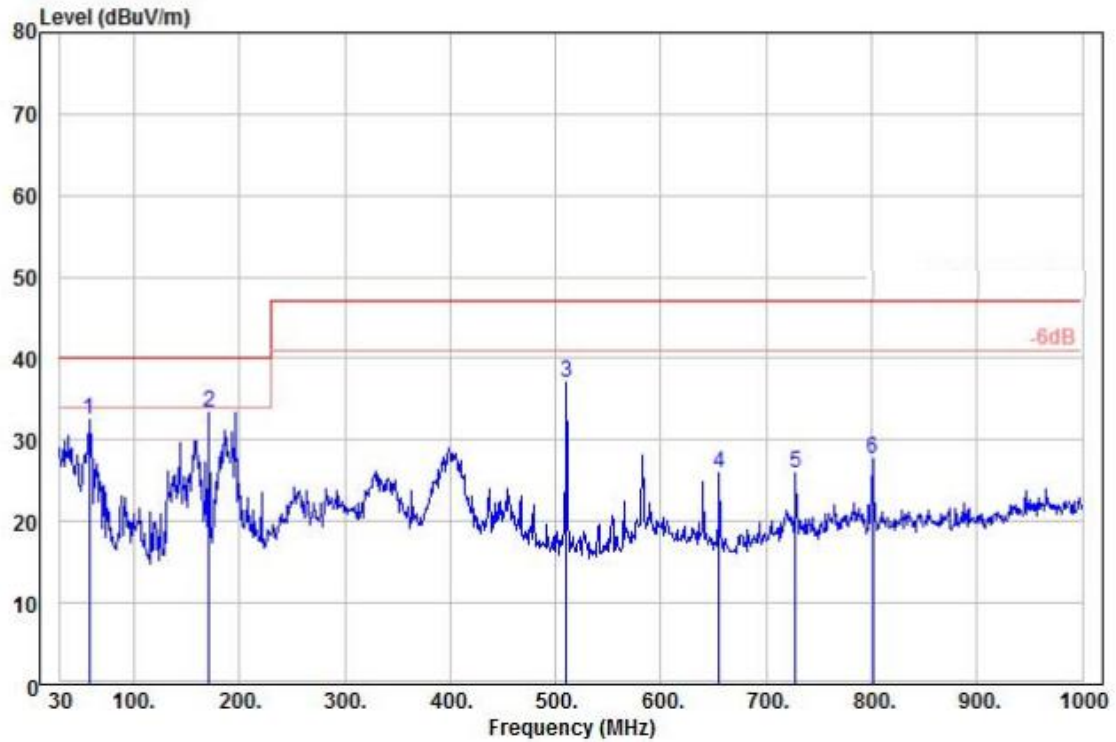

	Read	Limit	Over	Ant	Cable	Remark		
Freq	Level	Level	Factor	Line	Limit	Factor	Loss	Remark
MHz	dBuV/m	dBuV	dB/m	dBuV/m	dB	dB/m	dB	
1	57.16	32.52	48.99	-16.47	40.00	-7.48	13.39	0.59 Peak
2	171.62	33.44	50.70	-17.26	40.00	-6.56	12.29	0.96 Peak
3	510.15	36.96	47.96	-11.00	47.00	-10.04	17.29	1.69 Peak
4	655.65	25.87	33.63	-7.76	47.00	-21.13	20.03	1.95 Peak
5	728.40	25.84	31.67	-5.83	47.00	-21.16	21.74	2.07 Peak
6	801.15	27.65	32.26	-4.61	47.00	-19.35	22.71	2.18 Peak

Remark:

1.All possible modes of operation were investigated, and testing at two nominal voltages of 230V/50Hz and 110V/60Hz, only the worst case emissions reported.

7.3. RADIATED EMISSION MEASUREMENT (1000MHz-6000MHz)

7.3.1. LIMITS

FREQUENCY (MHz)	Class A(At 3m)		Class B(At 3m)	
	Peak dB(V/m)	Average dB(V/m)	Peak dB(V/m)	Average dB(V/m)
1000 ~ 3000	56	76	50	70
3000 ~ 6000	60	80	54	74

Note: 1) The lower limit shall apply at the transition frequencies.

2) Emission level (dB V/m) = 20 log Emission level (V/m).

7.3.2. TEST PROCEDURE

The equipment was set up as per the test configuration to simulate typical usage per the user's manual. When the EUT is a tabletop system, a wooden turntable with a height of 0.8 meters is used which is placed on the ground plane. When the EUT is floor standing equipment, it is placed on the ground plane which has a 0.1 m non-conductive covering to insulate the EUT from the ground plane.

The antenna was placed at 3 meter away from the EUT. The antenna connected to the spectrum analyzer via a cable and at times a pre-amplifier would be used.

The analyzer / receiver quickly scanned from 1000 MHz to 6000 MHz. The EUT test program was started. Emissions were scanned and measured rotating the EUT to 360 degrees and positioning the antenna 1 to 4 meters above the ground plane, in both the vertical and the horizontal polarization, to maximize the emission reading level.

During the above scans, the emissions were maximized by cable manipulation. Each modes is measured, recorded at least the six highest emissions. The emission frequency, amplitude, antenna position, polarization and turntable position were recorded into a computer in which correction factors were used to calculate the emission level and compare reading to the applicable limit and only Q.P. reading is presented.

The test data of the worst-case condition(s) was recorded.

Note: Test Software Name: e3, Software Version: 8.2.1.0.

7.3.3. TEST SETUP

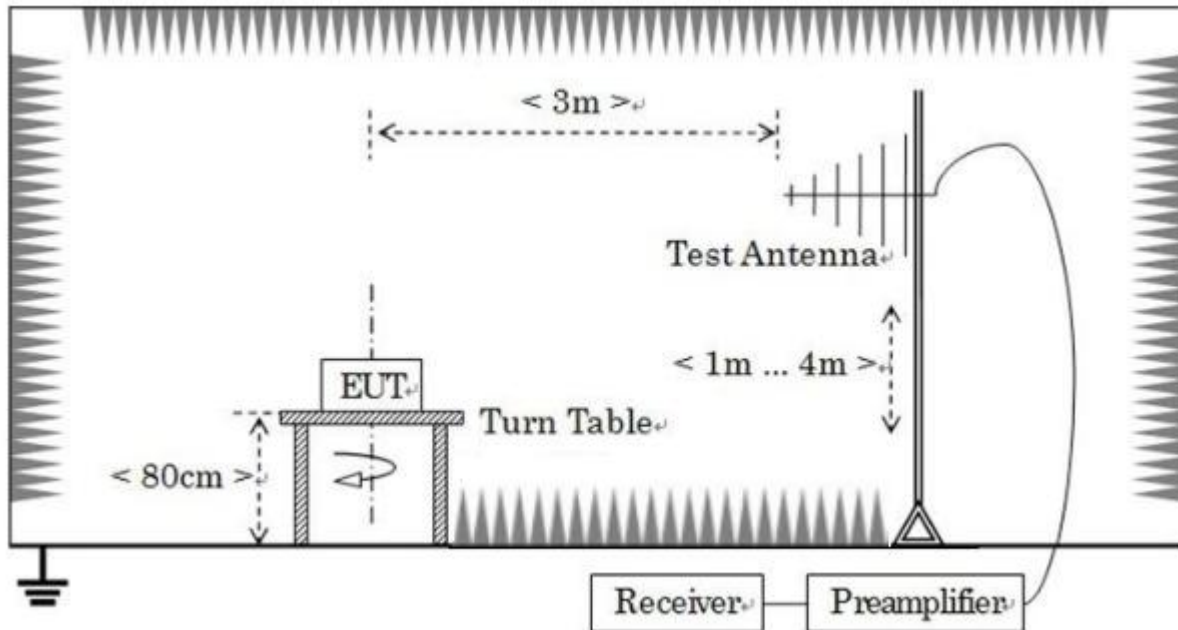

Note: For the actual test configuration, please refer to the related item – Photographs of the Test Configuration

7.3.4. TEST RESULT

Product name	7kW AC EV Charger	Antenna Distance	3 m
Model	PAC—CE7002	Antenna Pole	Vertical / Horizontal
Test Mode	Full Load	Detector Function	Average /Peak
Environmental Conditions	24.1 °C, 51 % RH, 101.22 kPa	Bandwidth	1 MHz
Tested by	Brian	Test Result	Pass

Note:

Freq. = Emission frequency in MHz

Reading level (dB V) = Receiver reading(dB V)

Corr.Factor (dB/m)=Antenna factor(dB/m)+Cable loss(dB)-Preamp Factor(dB)

Measurement (dB V/m)=Reading level(dB V)+ Corr. Factor (dB/m)

Limit (dB V/m) = Limit stated in standard

Over Limit (dB) = Measurement (dB V/m) – Limit (dB V/m)

QP = Quasi-Peak

Horizontal:

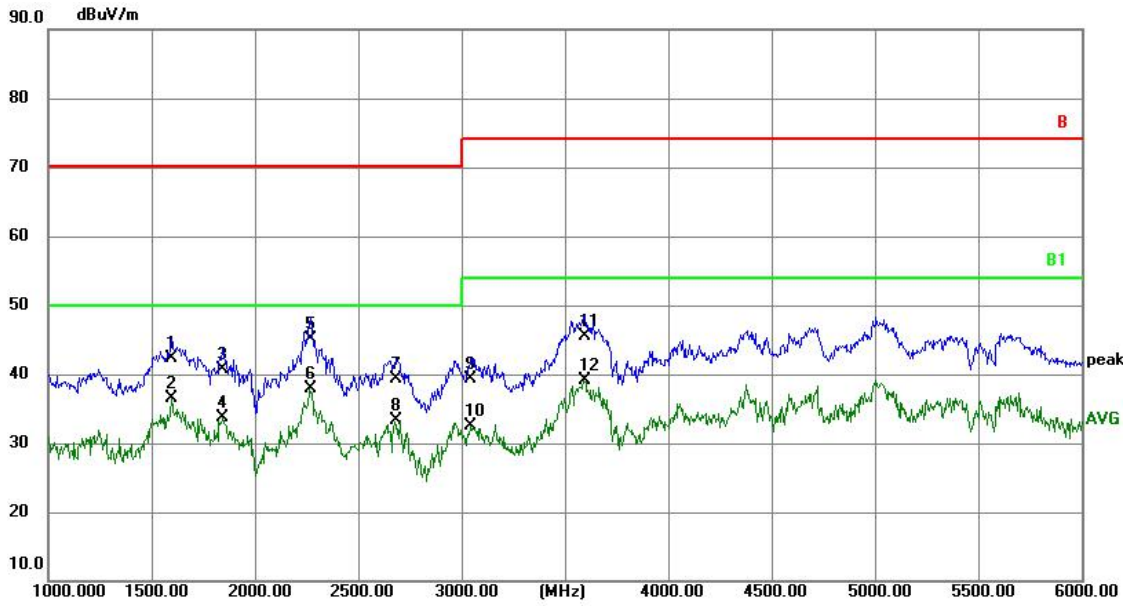

No.	Frequency (MHz)	Factor (dBuV/m)	Reading (dBuV)	Level (dBuV/m)	Limit (dBuV/m)	Over (dB)	Detector	MK.	Remark
1	1595.000	-5.99	48.29	42.30	70.00	-27.70	QP		
2	1595.000	-5.99	42.54	36.55	50.00	-13.45	AVG		
3	1845.000	-5.20	45.90	40.70	70.00	-29.30	QP		
4	1845.000	-5.20	38.84	33.64	50.00	-16.36	AVG		
5	2270.000	-3.85	49.05	45.20	70.00	-24.80	QP		
6	2270.000	-3.85	41.66	37.81	50.00	-12.19	AVG	*	
7	2685.000	-2.54	41.84	39.30	70.00	-30.70	QP		
8	2685.000	-2.54	35.75	33.21	50.00	-16.79	AVG		
9	3045.000	-1.56	40.96	39.40	74.00	-34.60	QP		
10	3045.000	-1.56	34.13	32.57	54.00	-21.43	AVG		
11	3595.000	10.73	34.77	45.50	74.00	-28.50	QP		
12	3595.000	10.73	28.40	39.13	54.00	-14.87	AVG		

Vertical:

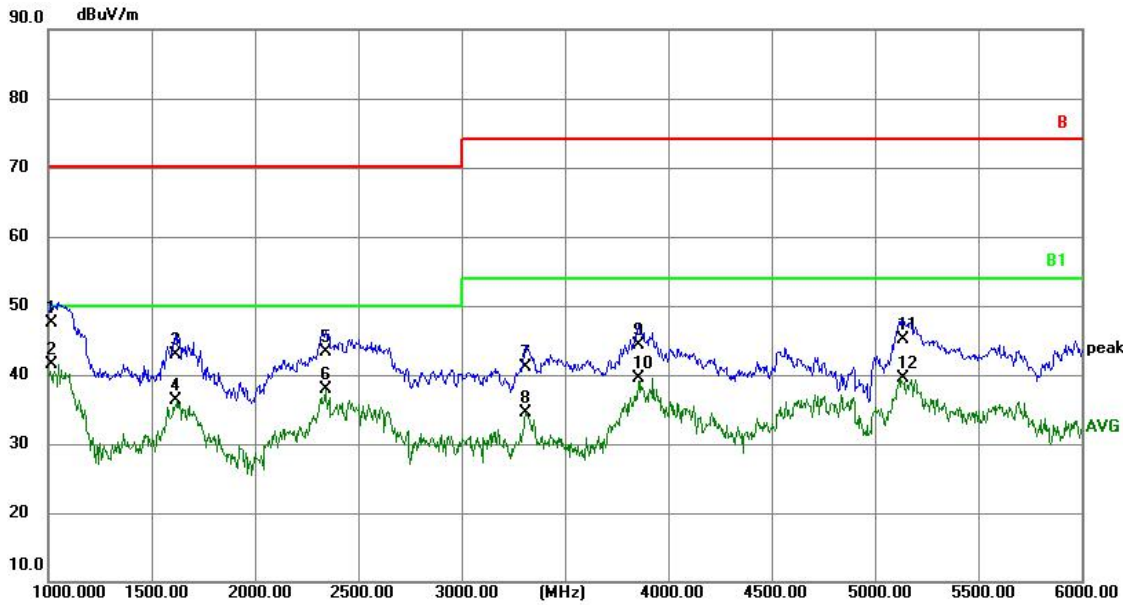

No.	Frequency (MHz)	Factor (dBuV/m)	Reading (dBuV)	Level (dBuV/m)	Limit (dBuV/m)	Over (dB)	Detector	MK.	Remark
1	1015.000	-7.79	55.29	47.50	70.00	-22.50	QP		
2	1015.000	-7.79	49.28	41.49	50.00	-8.51	AVG	*	
3	1615.000	-5.92	48.92	43.00	70.00	-27.00	QP		
4	1615.000	-5.92	42.25	36.33	50.00	-13.67	AVG		
5	2345.000	-3.62	47.02	43.40	70.00	-26.60	QP		
6	2345.000	-3.62	41.54	37.92	50.00	-12.08	AVG		
7	3310.000	-1.74	42.94	41.20	74.00	-32.80	QP		
8	3310.000	-1.74	36.34	34.60	54.00	-19.40	AVG		
9	3855.000	12.86	31.44	44.30	74.00	-29.70	QP		
10	3855.000	12.86	26.66	39.52	54.00	-14.48	AVG		
11	5135.000	16.60	28.50	45.10	74.00	-28.90	QP		
12	5135.000	16.60	22.93	39.53	54.00	-14.47	AVG		

Remark:

1. All possible modes of operation were investigated, and testing at two nominal voltages of 230V/50Hz and 110V/60Hz, only the worst case emissions reported.

7.4. HARMONICS CURRENT MEASUREMENT

7.4.1. LIMITS OF HARMONICS CURRENT MEASUREMENT

Limit for Class A equipment		Limit for Class D equipment		
Harmonics Order N	Max. permissible harmonics current A	Harmonics Order n	Max. permissible harmonics current per watt mA/W	Max. permissible harmonics current A
Odd harmonics		Odd Harmonics only		
3	2.30	3	3.4	2.30
5	1.14	5	1.9	1.14
7	0.77	7	1.0	0.77
9	0.40	9	0.5	0.40
11	0.33	11	0.35	0.33
13	0.21	13	0.30	0.21
$15 \leq n \leq 39$	$0.15 \times (15/n)$	$15 \leq n \leq 39$ (odd harmonics only)	$3.85/n$	$0.15 \times (15/n)$
Even harmonics				
2	1.08			
4	0.43			
6	0.30			
$8 \leq n \leq 40$	$0.23 \times 8/n$			

Limit for Class C equipment	
Harmonics Order n	Max. permissible harmonics current expressed as a percentage of the input current at the fundamental frequency A
2	2
3	$30 \times F$
5	10
7	7
9	5
$11 \leq n < \leq 39$ (odd harmonics only)	3

F is the circuit power factor

Note: Class A, B, C and D are classified according to item 7.3.2. of this report

7.4.2. TEST PROCEDURES

The EUT was placed on the top of a wooden table 0.8 meters above the ground and operated to produce the maximum harmonic. The classification of EUT is according to section 5 of IEC 61000-3-2.

The EUT is classified as follows:

Class A:

Balanced three-phase equipment, Household appliances excluding equipment as Class D, Tools excluding portable tools, Dimmers for incandescent lamps, audio equipment, equipment not specified in one of the three other classes.

Class B:

Portable tools; Arc welding equipment which is not professional equipment.

Class C:

Lighting equipment

Class D:

Equipment having a specified power less than or equal to 600 W of the following types: Personal computers and personal computer monitors and television receivers.

The correspondent test program of test instrument to measure the current harmonics emanated from EUT is chosen. The measure time shall be not less than the time necessary for the EUT to be exercised.

7.4.3. TEST SETUP

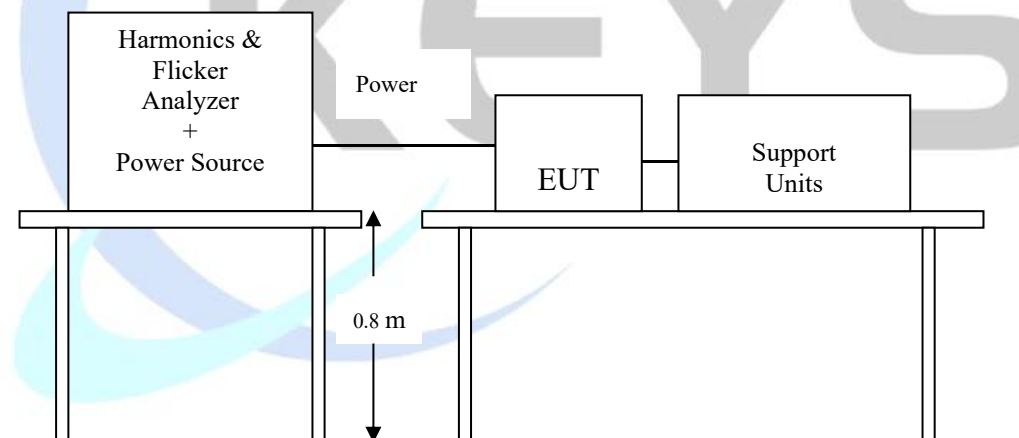

For the actual test configuration, please refer to the related item – Photographs of the Test Configuration.

7.4.4. TEST RESULT

Product	7kW AC EV Charger	Tested by	Brian
Model	PAC—CE7002	Limits	Class <input type="checkbox"/> A <input type="checkbox"/> B <input checked="" type="checkbox"/> C <input type="checkbox"/> D
Test Mode	Lighting	Observation Period (Tp)	2.5 mins
Environmental Conditions	24.3 °C, 54.1 % RH, 101.1 kPa	Test Result	Pass



Please refer to the following test data:

EUT: 7kW AC EV Charger **M/N: PAC—CE7002** **Tested by: Brian**
Test category: Class-C per Ed. 4.0 (2014) (European limits) **Test Margin: 100**
Test date: 2024/11/08 **Start time: 17:02:36** **End time: 17:57:57**
Test duration (min): 5 **Data file name: H-000237.cts_data**
Comment: Lighting
Customer:
Test Result: Pass **Source qualification: Normal**

Current & voltage waveforms

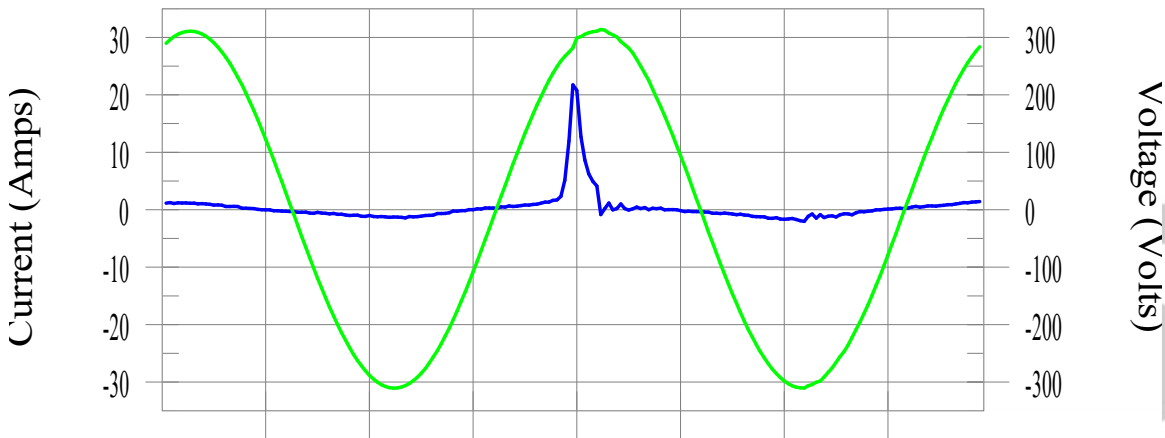

Harmonics and Class C limit line

European Limits

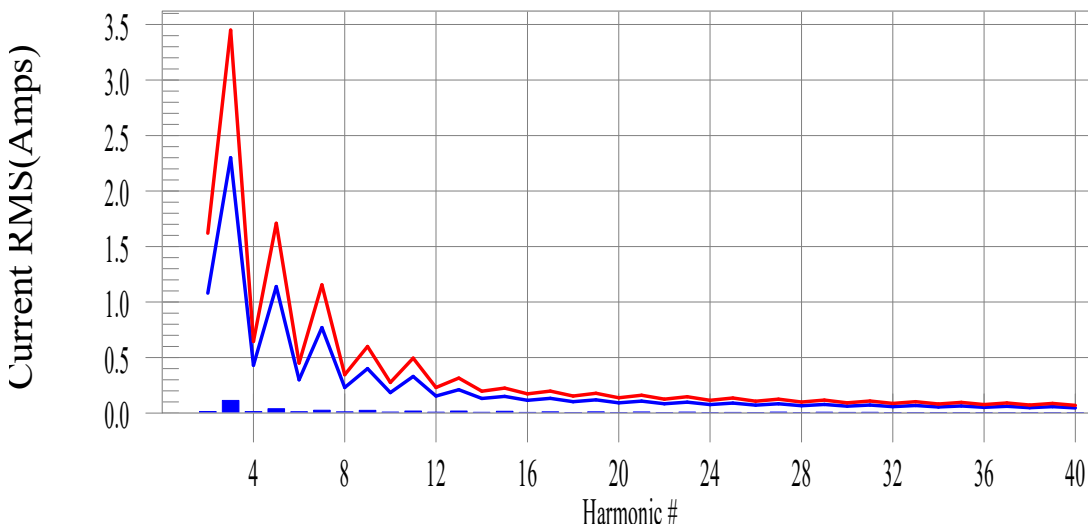

Test result: Pass Worst harmonics H5-62.1% of 150% limit, H5-91.5% of 100% limit.



Current Test Result Summary (Run time)

EUT: 7kW AC EV Charger M/N: PAC—CE7002 Tested by: Brian
 Test category: Class-C per Ed. 4.0 (2014) (European limits) Test Margin: 100
 Test date: 2024/11/08 Start time: 09:00:00 End time: 10:15:32
 Test duration (min): 5 Data file name: H-000012.cts_data
 Comment: Lighting
 Customer:

Test Result: Pass Source qualification: Normal
 THC(A): 0.135 I-THD(%): 14.8 POHC(A): 0.022 POHC Limit(A): 0.251

Highest parameter values during test:

Voltage (Vrms): 230.08 Frequency(Hz): 50.00
 I_Peak (Amps): 30.4253 I_RMS (Amps): 30.4159
 I_Fund (Amps): 30.4244 Crest Factor: 30.4131
 Power (Watts): 7000.05 Power Factor: 0.978

Harm#	Harms(avg)	100%Limit	%of Limit	Harms(max)	150%Limit	%of Limit	Status
2	0.014	1.080	1.3	0.072	1.620	4.4	Pass
3	0.114	2.300	5.0	0.180	3.450	5.2	Pass
4	0.013	0.430	3.1	0.080	0.645	12.4	Pass
5	0.039	1.140	3.4	0.112	1.710	6.6	Pass
6	0.012	0.300	4.0	0.080	0.450	17.8	Pass
7	0.025	0.770	3.2	0.058	1.155	5.0	Pass
8	0.011	0.230	4.6	0.066	0.345	19.1	Pass
9	0.025	0.400	6.2	0.043	0.600	7.1	Pass
10	0.009	0.184	5.1	0.048	0.276	17.4	Pass
11	0.018	0.330	5.4	0.033	0.495	6.6	Pass
12	0.008	0.153	5.3	0.040	0.230	17.5	Pass
13	0.018	0.210	8.5	0.048	0.315	15.2	Pass
14	0.007	0.131	5.4	0.040	0.197	20.4	Pass
15	0.016	0.150	10.7	0.035	0.225	15.4	Pass
16	0.006	0.115	5.3	0.036	0.173	21.1	Pass
17	0.011	0.132	8.0	0.037	0.198	18.5	Pass

18	0.005	0.102	N/A	0.027	0.153	N/A	Pass
19	0.011	0.118	9.3	0.037	0.178	20.6	Pass
20	0.004	0.092	N/A	0.019	0.138	N/A	Pass
21	0.010	0.107	8.9	0.016	0.161	10.1	Pass
22	0.003	0.084	N/A	0.018	0.125	N/A	Pass
23	0.008	0.098	8.6	0.014	0.147	9.3	Pass
24	0.003	0.077	N/A	0.016	0.115	N/A	Pass
25	0.005	0.090	5.9	0.012	0.135	9.0	Pass
26	0.003	0.071	N/A	0.009	0.107	N/A	Pass
27	0.008	0.083	10.0	0.017	0.125	13.3	Pass
28	0.004	0.066	N/A	0.010	0.099	N/A	Pass
29	0.007	0.078	9.4	0.021	0.116	18.3	Pass
30	0.005	0.061	8.6	0.012	0.092	13.5	Pass
31	0.007	0.073	9.9	0.013	0.109	12.0	Pass
32	0.005	0.058	N/A	0.010	0.086	N/A	Pass
33	0.005	0.068	N/A	0.011	0.102	N/A	Pass
34	0.003	0.054	N/A	0.007	0.081	N/A	Pass
35	0.004	0.064	N/A	0.008	0.096	N/A	Pass
36	0.002	0.051	N/A	0.006	0.077	N/A	Pass
37	0.004	0.061	N/A	0.009	0.091	N/A	Pass
38	0.002	0.048	N/A	0.006	0.073	N/A	Pass
39	0.003	0.058	N/A	0.007	0.087	N/A	Pass
40	0.003	0.046	N/A	0.006	0.069	N/A	Pass

Note: Dynamic limits were applied for this test. The highest harmonics values in the above table may not occur at the same window as the maximum harmonics/limit ratio.



Voltage Source Verification Data (Run time)

EUT: 7kW AC EV Charger M/N: PAC—CE7002 Tested by: Brian
 Test category: Class-C per Ed. 4.0 (2014) (European limits) Test Margin: 100
 Test date: 2024/11/08 Start time: 09:00:00 End time: 10:15:32
 Test duration (min): 5 Data file name: H-000012.cts_data
 Comment: Lighting
 Customer:

Test Result: Pass Source qualification: Normal

Highest parameter values during test:

Voltage (Vrms): 230.08 Frequency(Hz): 50.00
 I_Peak (Amps): 30.4253 I_RMS (Amps): 30.4159
 I_Fund (Amps): 30.4244 Crest Factor: 30.4131
 Power (Watts): 7000.05 Power Factor: 0.978

Harm#	Harmonics V-rms	Limit V-rms	% of Limit	Status
2	0.088	0.440	19.95	OK
3	0.429	1.978	21.69	OK
4	0.055	0.440	12.61	OK
5	0.039	0.879	4.47	OK
6	0.049	0.440	11.07	OK
7	0.046	0.659	7.01	OK
8	0.029	0.440	6.67	OK
9	0.036	0.440	8.11	OK
10	0.027	0.440	6.11	OK
11	0.024	0.220	10.95	OK
12	0.020	0.220	9.30	OK
13	0.030	0.220	13.44	OK
14	0.020	0.220	8.96	OK
15	0.019	0.220	8.69	OK
16	0.023	0.220	10.61	OK
17	0.017	0.220	7.74	OK
18	0.020	0.220	9.31	OK



Report No.: KEYS241105047002EM-02

19	0.019	0.220	8.60	OK
20	0.024	0.220	11.04	OK
21	0.018	0.220	7.97	OK
22	0.013	0.220	5.82	OK
23	0.017	0.220	7.74	OK
24	0.011	0.220	5.22	OK
25	0.014	0.220	6.25	OK
26	0.014	0.220	6.43	OK
27	0.016	0.220	7.25	OK
28	0.012	0.220	5.25	OK
29	0.019	0.220	8.75	OK
30	0.010	0.220	4.53	OK
31	0.019	0.220	8.63	OK
32	0.011	0.220	4.87	OK
33	0.015	0.220	6.99	OK
34	0.011	0.220	5.16	OK
35	0.016	0.220	7.37	OK
36	0.011	0.220	4.97	OK
37	0.014	0.220	6.25	OK
38	0.010	0.220	4.46	OK
39	0.015	0.220	6.97	OK
40	0.023	0.220	10.48	OK

7.5. VOLTAGE FLUCTUATION AND FLICKS MEASUREMENT

7.5.1. LIMITS OF VOLTAGE FLUCTUATION AND FLICKS MEASUREMENT

TEST ITEM	LIMIT	REMARK
P_{st}	1.0	P_{st} means short-term flicker indicator.
P_{lt}	0.65	P_{lt} means long-term flicker indicator.
T_{dt} (ms)	500	T_{dt} means maximum time that dt exceeds 3 %.
d_{max} (%)	4/6/7 %	d_{max} means maximum relative voltage change.
dc (%)	3.3 %	dc means relative steady-state voltage change

7.5.2. TEST PROCEDURE

The EUT was placed on the top of a wooden table 0.8 meters above the ground and operated to produce the most unfavorable sequence of voltage changes under full load operating conditions.

During the flick measurement, the measure time shall include that part of whole operation cycle in which the EUT produce the most unfavorable sequence of voltage changes. The observation period for short-term flicker indicator is 10 minutes and the observation period for long-term flicker indicator is 2 hours.

7.5.3. TEST SETUP

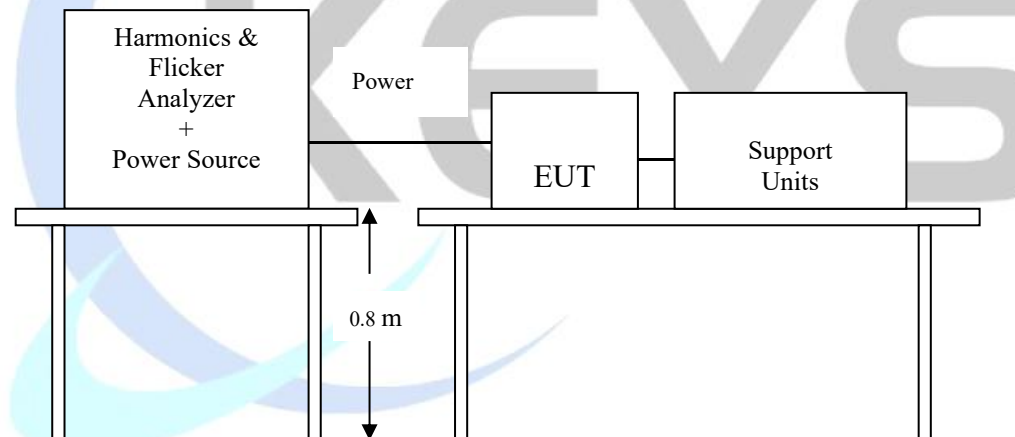

For the actual test configuration, please refer to the related item – Photographs of the Test Configuration.

7.5.4. TEST RESULT

Product	7kW AC EV Charger	Tested by	Brian
Model	PAC—CE7002	Observation Period (Tp)	10 mins
Test Mode	Full Load	Test Result	Pass
Environmental Conditions	24.1°C, 51 % RH, 101.12 kPa		

8. IMMUNITY TEST

8.1. GENERAL DESCRIPTION

Product Standard	IMMUNITY	
	Test Type	Minimum Requirement
Basic Standard, Specification, and Performance Criterion required	IEC 61000-4-2	Electrostatic Discharge – ESD: 8 kV air discharge, 4 kV Contact discharge, Performance Criterion B
	IEC 61000-4-3	Radio-Frequency Electromagnetic Field Susceptibility Test – RS: 80MHz-1000MHz, 1400MHz-2000MHz, 2000MHz-2700MHz, 3 V/m, 80 % AM(1 kHz), Performance Criterion A
	IEC 61000-4-4	Electrical Fast Transient/Burst - EFT, Power line: 2 kV, Signal line: 1 kV, Performance Criterion B
	IEC 61000-4-5	Surge Immunity Test: 1.2/50 μ s Open Circuit Voltage, 8 /20 μ s Short Circuit Current, Power Port ~ Line to line: 1 kV, Line to earth: 2 kV Signal Port : 1kV Performance Criterion B
	IEC 61000-4-6	Conducted Radio Frequency Disturbances Test –CS: 0.15MHz-80MHz; 3 V r.m.s, 80 % AM, 1 kHz, Performance Criterion A
	IEC 61000-4-8	Power frequency magnetic field immunity test 50 Hz, 60 Hz 30 A/m (for systems \leq 32 A) 100 A/m (for systems $>$ 32 A) Performance Criterion A

	IEC 61000-4-11	<p>Voltage Dips:</p> <ul style="list-style-type: none">i) 40% reduction for 10/12 cycles at 50/60 Hz Performance Criterion Bii) 70% reduction for 25/30 cycles at 50/60 Hz, Performance Criterion B <p>Voltage Interruptions:</p> <ul style="list-style-type: none">i) 0% reduction for 1 cycles at 50/60 Hz, Performance Criterion Bii) 0% reduction for 250/300 cycles at 50/60 Hz, Performance Criterion C
--	----------------	---



8.2. GENERAL PERFORMANCE CRITERIA DESCRIPTION

<p>Criteria A:</p>	<p>During and after the test the EUT shall continue to operate as intended without operator intervention. No degradation of performance or loss of function is allowed below a minimum performance level specified by the manufacturer when the EUT is used as intended. The performance level may be replaced by a permissible loss of performance. If the minimum performance level or the permissible performance loss is not specified by the manufacturer, then either of these may be derived from the product description and documentation, and by what the user may reasonably expect from the EUT if used as intended.</p>
<p>Criteria B:</p>	<p>After the test, the EUT shall continue to operate as intended without operator intervention. No degradation of performance or loss of function is allowed, after the application of the phenomena below a performance level specified by the manufacturer, when the EUT is used as intended. The performance level may be replaced by a permissible loss of performance.</p> <p>During the test, degradation of performance is allowed. However, no change of operating state or stored data is allowed to persist after the test. If the minimum performance level (or the permissible performance loss) is not specified by the manufacturer, then either of these may be derived from the product description and documentation, and by what the user may reasonably expect from the EUT if used as intended.</p>
<p>Criteria C:</p>	<p>During and after testing, a temporary loss of function is allowed, provided the function is self-recoverable, or can be restored by the operation of the controls or cycling of the power to the EUT by the user in accordance with the manufacturer's instructions.</p> <p>Functions, and/or information stored in non-volatile memory, or protected by a battery backup, shall not be lost.</p>

8.3. ELECTROSTATIC DISCHARGE (ESD)

8.3.1. TEST SPECIFICATION

Basic Standard:	IEC 61000-4-2
Discharge Impedance:	330 Ω
Charging Capacity:	150 pF
Discharge Voltage:	Air Discharge: 8 kV (Direct) Contact Discharge: 4 kV (Direct/Indirect)
Polarity:	Positive & Negative
Number of Discharge:	10 (Air discharge for single polarity discharge) 25 (Contact discharge for single polarity discharge)
Discharge Mode:	1 time/s
Performance Criterion:	B

8.3.2. TEST PROCEDURE

The discharges shall be applied in two ways:

- a) Contact discharges to the conductive surfaces and coupling planes:
50 dischargers (25 with positive and 25 with negative polarity) shall be applied on each accessible metallic part of the enclosure, terminals are excluded. In case of a non-conductive enclosure, dischargers shall be applied on the horizontal or vertical coupling planes. Test shall be performed at a maximum repetition rate of one discharge per second.
- b) Air discharges at slots and apertures and insulating surfaces:
On those parts of the EUT where it is not possible to perform contact discharge testing, the equipment should be investigated to identify user accessible points where breakdown may occur. Such points are tested using the air discharge method. This investigation should be restricted to those area normally handled by the user. A minimum of 10 single air discharges shall be applied to the selected test point for each such area.

The basic test procedure was in accordance with IEC 61000-4-2:

- a) The EUT was located 0.1 m minimum from all side of the HCP (dimensions 1.6 m x 0.8 m).
- b) The support units were located another table 30 cm away from the EUT, but direct support unit was/were located at same location as EUT on the HCP and keep at a distance of 10cm with EUT.
- c) The time interval between two successive single discharges was at least 1 second.

- d) Contact discharges were applied to the non-insulating coating, with the pointed tip of the generator penetrating the coating and contacting the conducting substrate.
- e) Air discharges were applied with the round discharge tip of the discharge electrode approaching the EUT as fast as possible (without causing mechanical damage) to touch the EUT. After each discharge, the ESD generator was removed from the EUT and re-triggered for a new single discharge. The test was repeated until all discharges were complete.
- f) At least ten single discharges (in the most sensitive polarity) were applied at the front edge of each HCP opposite the center point of each unit of the EUT and 0.1 meter from the front of the EUT. The long axis of the discharge electrode was in the plane of the HCP and perpendicular to its front edge during the discharge.
- g) At least ten single discharges (in the most sensitive polarity) were applied to the center of one vertical edge of the Vertical Coupling Plane (VCP) in sufficiently different positions that the four faces of the EUT were completely illuminated. The VCP (dimensions 0.5 m x 0.5 m) was placed vertically to and 0.1 meter from the EUT.

A large, semi-transparent watermark of the KEYS logo is centered on the page. It consists of the word "KEYS" in a large, grey, sans-serif font, with the same blue orbital graphic behind it.

8.3.3. TEST SETUP

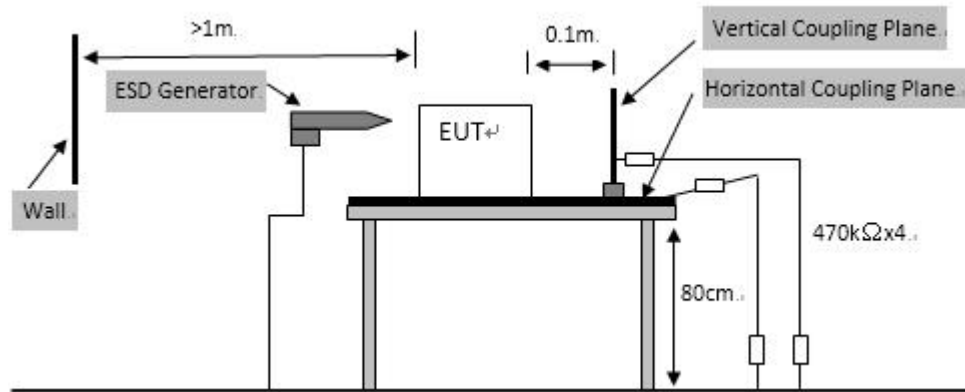

For the actual test configuration, please refer to the related item – Photographs of the Test Configuration.

Note:

1) TABLE-TOP EQUIPMENT

The configuration consisted of a wooden table 0.8 meters high standing on the ground reference plane (GRP). The GRP consisted of a sheet of aluminum at least 0.25 mm thick, and 2.5 meters square connected to the protective grounding system. A horizontal coupling plane (HCP) (1.6 m x 0.8 m) was placed on the table and attached to the GRP by means of a cable with 940k total impedance. The equipment under test, was installed in a representative system as described in section 7 of IEC 61000-4-2, and its cables were placed on the HCP and isolated by an insulating support of 0.5 mm thickness. A distance of 1-meter minimum was provided between the EUT and the walls of the laboratory and any other metallic structure.

2) FLOOR-STANDING EQUIPMENT

The equipment under test was installed in a representative system as described in section 7 of IEC 61000-4-2, and its cables were isolated from the ground reference plane by an insulating support of 0.1 meter thickness. The GRP consisted of a sheet of aluminum that is at least 0.25 mm thick, and 2.5 meters square connected to the protective grounding system and extended at least 0.5 meters from the EUT on all sides.

8.3.4. TEST RESULT

Product	7kW AC EV Charger	Environmental Conditions	24.1 °C, 51.2 % RH, 101.14 kPa
Model	PAC—CE7002	Tested By	Brian
Test mode	Full Load	Test Result	Pass

Air Discharge					
Test Points	Test Levels	Results			
	8 Kv	Pass	Fail	Observation	Performance Criterion
Slot 5 Points	<input checked="" type="checkbox"/>	<input checked="" type="checkbox"/>	<input type="checkbox"/>	Note <input type="checkbox"/> 1 <input checked="" type="checkbox"/> 2 <input type="checkbox"/> 3	B
Buttons 9 Points	<input checked="" type="checkbox"/>	<input checked="" type="checkbox"/>	<input type="checkbox"/>	Note <input type="checkbox"/> 1 <input checked="" type="checkbox"/> 2 <input type="checkbox"/> 3	B
LED 1 Point	<input checked="" type="checkbox"/>	<input checked="" type="checkbox"/>	<input type="checkbox"/>	Note <input type="checkbox"/> 1 <input checked="" type="checkbox"/> 2 <input type="checkbox"/> 3	B
Ports 6 Points	<input checked="" type="checkbox"/>	<input checked="" type="checkbox"/>	<input type="checkbox"/>	Note <input type="checkbox"/> 1 <input checked="" type="checkbox"/> 2 <input type="checkbox"/> 3	B

Contact Discharge					
Test Points	Test Levels	Results			
	4 Kv	Pass	Fail	Observation	Performance Criterion
Screw 4 Points	<input checked="" type="checkbox"/>	<input checked="" type="checkbox"/>	<input type="checkbox"/>	Note <input type="checkbox"/> 1 <input checked="" type="checkbox"/> 2 <input type="checkbox"/> 3	B
Enclosure 6 Points	<input checked="" type="checkbox"/>	<input checked="" type="checkbox"/>	<input type="checkbox"/>	Note <input type="checkbox"/> 1 <input checked="" type="checkbox"/> 2 <input type="checkbox"/> 3	B
HCP 4 Points	<input checked="" type="checkbox"/>	<input checked="" type="checkbox"/>	<input type="checkbox"/>	Note <input type="checkbox"/> 1 <input checked="" type="checkbox"/> 2 <input type="checkbox"/> 3	B
VCP 4 Points	<input checked="" type="checkbox"/>	<input checked="" type="checkbox"/>	<input type="checkbox"/>	Note <input type="checkbox"/> 1 <input checked="" type="checkbox"/> 2 <input type="checkbox"/> 3	B

Note:

- 1) There was no change compared with initial operation during the test.
- 2) During the test, the sound appears to be broken. After the test, the sound can return to its original value within 1 minute.
- 3) During the test, the sound appears to be broken and after the test the sound can return to normal within 30 min.

8.4. RADIATED, RADIO-FREQUENCY, ELECTROMAGNETIC FIELD (RS)

8.4.1. TEST SPECIFICATION

Basic Standard:	IEC 61000-4-3
Frequency Range:	80 - 2,700MHz
Field Strength:	3V/m: 80 – 1000MHz 3V/m: 1.4 – 2.0GHz 3V/m: 2.0 – 2.7GHz (Unmodulated, r.m.s.)
Modulation:	1 kHz Sine Wave, 80 %, AM Modulation
Frequency Step:	1 % of preceding frequency value
Polarity of Antenna:	Horizontal and Vertical
Test Distance:	3 m
Antenna Height:	1.5 m
Performance Criterion:	A

8.4.2. TEST PROCEDURE

The test procedure was in accordance with IEC 61000-4-3

- The testing was performed in a fully anechoic chamber. The transmit antenna was located at a distance of 3 meters from the EUT.
- The frequency range is swept from 80 MHz to 1000 MHz, with the signal 80% amplitude modulated with a 1 kHz sine-wave. The rate of sweep did not exceed 1.5×10^{-3} decade/s, where the frequency range is swept incrementally, the step size was 1 % of preceding frequency value.
- The dwell time at each frequency shall be not less than the time necessary for the EUT to be able to respond.
- The test was performed with the EUT exposed to both vertically and horizontally polarized fields on each of the four sides.

8.4.3. TEST SETUP

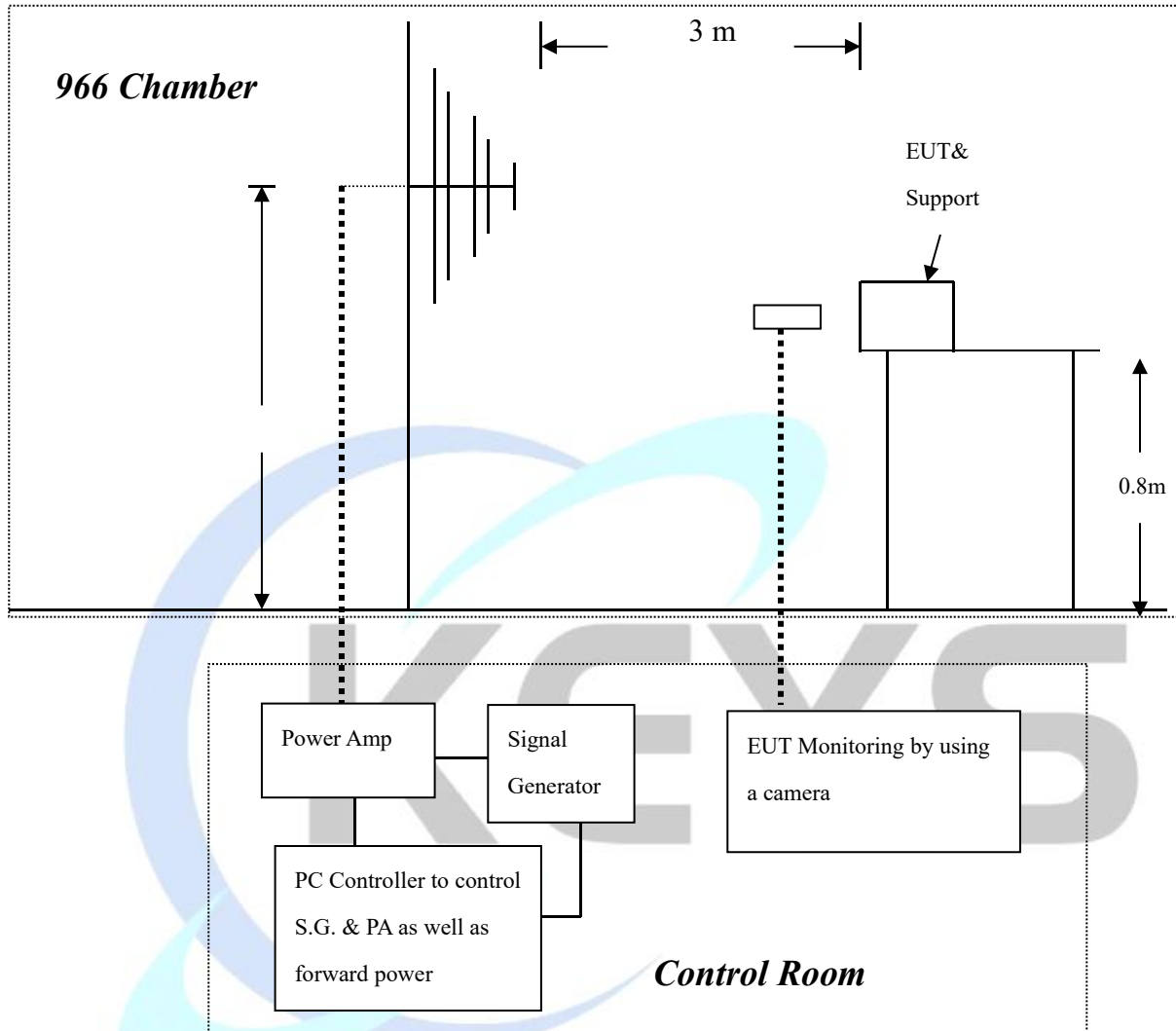

For the actual test configuration, please refer to the related item – Photographs of the Test Configuration.

Note:

TABLETOP EQUIPMENT

The EUT installed in a representative system as described in section 7 of IEC 61000-4-3 was placed on a non-conductive table 0.8 meters in height. The system under test was connected to the power and signal wire according to relevant installation instructions.

FLOOR STANDING EQUIPMENT

The EUT installed in a representative system as described in section 7 of IEC 61000-4-3 was placed on a non-conductive wood support 0.1 meters in height. The system under test was connected to the power and signal wire according to relevant installation instructions.

8.4.4. TEST RESULT

Product	7kW AC EV Charger	Environmental Conditions	24.1 °C, 51.1 % RH, 101.12 kPa
Model	PAC—CE7002	Tested By	Brian
Test mode	Full Load	Test Result	Pass

Frequency (MHz)	Polarity	Position	Field Strength (V/m)	Observation	Performance Criterion
80 ~ 1000	V&H	Front	3	Note <input checked="" type="checkbox"/> 1 <input type="checkbox"/> 2 <input type="checkbox"/> 3	A
80 ~ 1000	V&H	Rear	3	Note <input checked="" type="checkbox"/> 1 <input type="checkbox"/> 2 <input type="checkbox"/> 3	A
80 ~ 1000	V&H	Left	3	Note <input checked="" type="checkbox"/> 1 <input type="checkbox"/> 2 <input type="checkbox"/> 3	A
80 ~ 1000	V&H	Right	3	Note <input checked="" type="checkbox"/> 1 <input type="checkbox"/> 2 <input type="checkbox"/> 3	A
1400 ~2000	V&H	Front	3	Note <input checked="" type="checkbox"/> 1 <input type="checkbox"/> 2 <input type="checkbox"/> 3	A
1400 ~2000	V&H	Rear	3	Note <input checked="" type="checkbox"/> 1 <input type="checkbox"/> 2 <input type="checkbox"/> 3	A
1400 ~2000	V&H	Left	3	Note <input checked="" type="checkbox"/> 1 <input type="checkbox"/> 2 <input type="checkbox"/> 3	A
1400 ~2000	V&H	Right	3	Note <input checked="" type="checkbox"/> 1 <input type="checkbox"/> 2 <input type="checkbox"/> 3	A
2000 ~2700	V&H	Front	3	Note <input checked="" type="checkbox"/> 1 <input type="checkbox"/> 2 <input type="checkbox"/> 3	A
2000 ~2700	V&H	Rear	3	Note <input checked="" type="checkbox"/> 1 <input type="checkbox"/> 2 <input type="checkbox"/> 3	A
2000 ~2700	V&H	Left	3	Note <input checked="" type="checkbox"/> 1 <input type="checkbox"/> 2 <input type="checkbox"/> 3	A
2000 ~2700	V&H	Right	3	Note <input checked="" type="checkbox"/> 1 <input type="checkbox"/> 2 <input type="checkbox"/> 3	A

Note:

- 1) There was no change compared with initial operation during the test.
- 2) During the test, the sound appears to be broken. After the test, the sound can return to its original value within 1 minute.
- 3) During the test, the sound appears to be broken and after the test the sound can return to normal within 30 min.

8.5. ELECTRICAL FAST TRANSIENT (EFT)

8.5.1. TEST SPECIFICATION

Basic Standard:	IEC 61000-4-4
Test Voltage:	Power Line: 2 kV Signal/Control Line: 1 kV
Polarity:	Positive & Negative
Impulse Frequency:	5 kHz
Impulse Wave-shape:	5/50 ns
Burst Duration:	15 ms
Burst Period:	300 ms
Test Duration:	2 mins
Performance Criterion:	B

8.5.2. TEST PROCEDURE

EUT is placed on a 0.1 m tall wooden table.

EUT operate at normal mode, the transient/burst was 5/50 ns in accordance with IEC 61000-4-4, both positive and negative polarity burst waveform were applied.

The duration time of each test line was 2 minutes.

8.5.3. TEST SETUP

The EUT installed in a representative system as described in section 7 of IEC 61000-4-4.

For the actual test configuration, please refer to the related item – photographs of the test configuration.

8.5.4. TEST RESULT

Product	7kW AC EV Charger	Environmental Conditions	24.1 °C, 51.5 % RH, 101.1 kPa
Model	PAC—CE7002	Tested By	Brian
Test mode	Full Load	Test Result	Pass

Test Point	Polarity	Test Level (kV)	Observation	Performance Criterion
L	+/-	2	Note <input type="checkbox"/> 1 <input checked="" type="checkbox"/> 2 <input type="checkbox"/> 3	B
N	+/-	2	Note <input type="checkbox"/> 1 <input checked="" type="checkbox"/> 2 <input type="checkbox"/> 3	B
L – N	+/-	2	Note <input type="checkbox"/> 1 <input checked="" type="checkbox"/> 2 <input type="checkbox"/> 3	B
PE	--	--	N/A	N/A
L – PE	--	--	N/A	N/A
N – PE	--	--	N/A	N/A
L – N – PE	--	--	N/A	N/A
RJ45 UTP cable	--	--	N/A	N/A

Note:

- 1) There was no change compared with initial operation during the test.
- 2) During the test, the sound appears to be broken. After the test, the sound can return to its original value within 1 minute.
- 3) During the test, the sound appears to be broken and after the test the sound can return to normal within 30 min.

8.6. SURGE IMMUNITY TEST

8.6.1. TEST SPECIFICATION

Basic Standard:	IEC 61000-4-5 Combination Wave
Wave-Shape:	1.2/50 μ s Open Circuit Voltage 8/20 μ s Short Circuit Current
Test Voltage:	Power Port ~ Line to line: 1 kV, Line to ground: 2 kV
Surge Input/Output:	Power Line: L-N / L-PE / N-PE
Generator Source Impedance:	2 Ω between networks 12 Ω between network and ground
Polarity:	Positive/Negative
Phase Angle:	0° /90° /180° /270°
Pulse Repetition Rate:	1 time / min
Number of Tests:	5 positive polarity pulses, and 5 negative polarity pulses
Performance Criterion:	B

8.6.2. TEST PROCEDURE

EUT is placed on a 0.8 m tall wooden table.

EUT operate at normal mode, two types of combination wave generator (1.2/50 μ s open-circuit voltage and 8/20 μ s short-circuit current) are applied to the EUT power supply terminals via the capacitive coupling network.

The power cord between the EUT and the coupling/decoupling network shall not exceed 2 m in length.

8.6.3. TEST SETUP

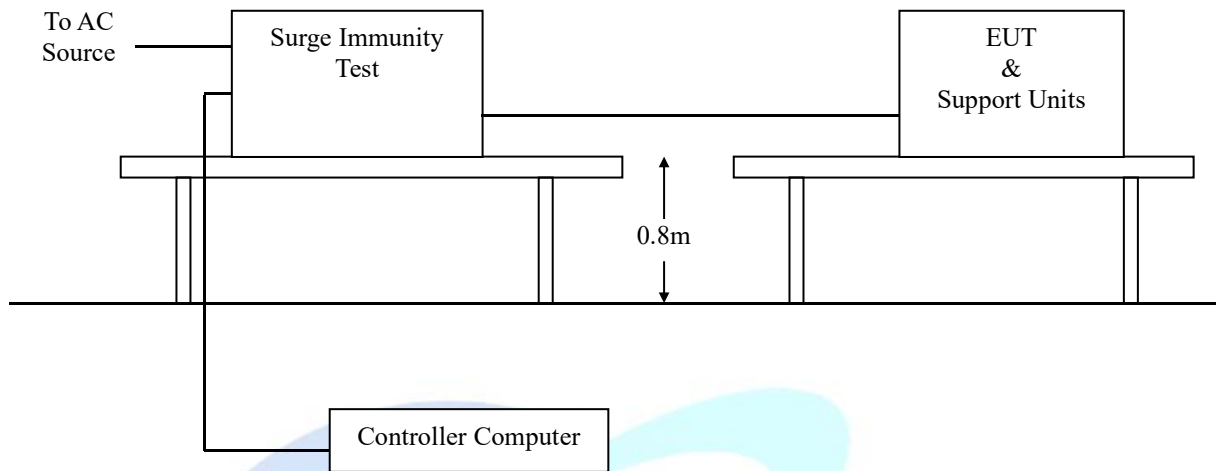

For the actual test configuration, please refer to the related item – Photographs of the Test Configuration.

8.6.4. TEST RESULT

Product	7kW AC EV Charger	Environmental Conditions	24.5°C, 51.5 % RH, 101.1 kPa
Model	PAC—CE7002	Tested By	Brian
Test mode	Full Load	Test Result	Pass

Test Point	Polarity	Test Level (kV)	Observation	Performance Criterion
L - N	+/-	1	Note <input type="checkbox"/> 1 <input checked="" type="checkbox"/> 2 <input type="checkbox"/> 3	B
L - PE	+/-	2	Note <input type="checkbox"/> 1 <input checked="" type="checkbox"/> 2 <input type="checkbox"/> 3	B
N - PE	+/-	2	Note <input type="checkbox"/> 1 <input checked="" type="checkbox"/> 2 <input type="checkbox"/> 3	B

Note:

- 1) There was no change compared with initial operation during the test.
- 2) During the test, the sound appears to be broken. After the test, the sound can return to its original value within 1 minute.
- 3) During the test, the sound appears to be broken and after the test the sound can return to normal within 30 min.

8.7. CONDUCTED RADIO FREQUENCY DISTURBANCES (CS)

8.7.1. TEST SPECIFICATION

Basic Standard:	IEC 61000-4-6
Frequency Range:	0.15MHz-80MHz: 3V
Field Strength:	3 V
Modulation:	1 kHz Sine Wave, 80 %, AM Modulation
Frequency Step:	1 % of preceding frequency value
Coupled cable:	Power Mains, Shielded
Coupling device:	CDN-M3/2 (3 wires/2 wires)
Performance Criterion:	A

8.7.2. TEST PROCEDURE

The EUT shall be tested within its intended operating and climatic conditions.

The test shall be performed with the test generator connected to each of the coupling and decoupling devices in turn, while the other non-excited RF input ports of the coupling devices are terminated by a 50 Ω load resistor.

The frequency range was swept from 150 kHz to 80 MHz, using the signal level established during the setting process and with a disturbance signal of 80 % amplitude. The signal was modulated with a 1 kHz sine wave, pausing to adjust the RF signal level or the switch coupling devices as necessary. The sweep rate was 1.5×10^{-3} decades/s. Where the frequency range is swept incrementally, the step size was 1 % of preceding frequency value the dwell time of the amplitude modulated carrier at each frequency was 0.5 s.

8.7.3. TEST SETUP

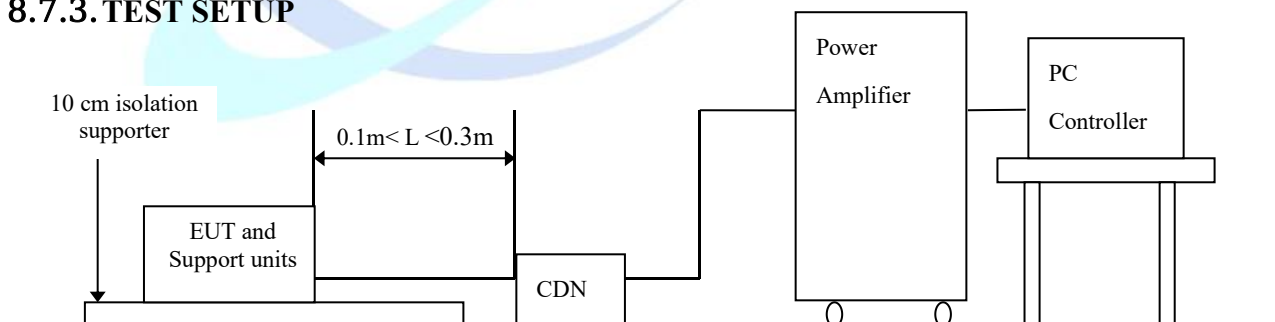

For the actual test configuration, please refer to the related item – Photographs of the Test Configuration

Note: 1) The EUT is setup 0.1 m above Ground Reference Plane

2) All relevant cables shall be provided with the appropriate coupling and decoupling devices at a distance between 0.1 meters and 0.3 meters from the projected geometry of the EUT on the ground reference plane.

8.7.4. TEST RESULT

Product	7kW AC EV Charger	Environmental Conditions	24.1°C, 51 % RH, 101.21 kPa
Model	PAC—CE7002	Tested By	Brian
Test mode	Full Load	Test Result	Pass

Frequency (MHz)	Field Strength (Vrms)	Injected Position	Injection Method	Observation	Performance Criterion
0.15-80	3	AC Mains	CDN-M2/M3	Note <input checked="" type="checkbox"/> 1 <input type="checkbox"/> 2 <input type="checkbox"/> 3	A

Note:

- 1) There was no change compared with initial operation during the test.
- 2) During the test, the sound appears to be broken. After the test, the sound can return to its original value within 1 minute.
- 3) During the test, the sound appears to be broken and after the test the sound can return to normal within 30 min.



8.8. POWER FREQUENCY MAGNETIC FIELD

8.8.1. TEST SPECIFICATION

Basic Standard:	IEC 61000-4-8
Frequency Range:	50 Hz, 60Hz
Field Strength:	30 A/m (for systems \leq 32 A) 100 A/m (for systems $>$ 32 A)
Observation Time:	5 minutes
Inductance Coil:	Rectangular type, 1 m x 1 m
Performance Criterion:	A

8.8.2. TEST PROCEDURE

The equipment is configured and connected to satisfy its functional requirements. It shall be placed on the GRP with the interposition of a 0.1 m-thick insulating support.

The equipment cabinets shall be connected to the safety earth directly on the GRP via the earth terminal of the EUT.

The power supply, input and output circuits shall be connected to the sources of power supply, control and signal.

The cables supplied or recommended by the equipment manufacturer shall be used. 1 meter of all cables used shall be exposed to the magnetic field.

8.8.3. TEST SETUP

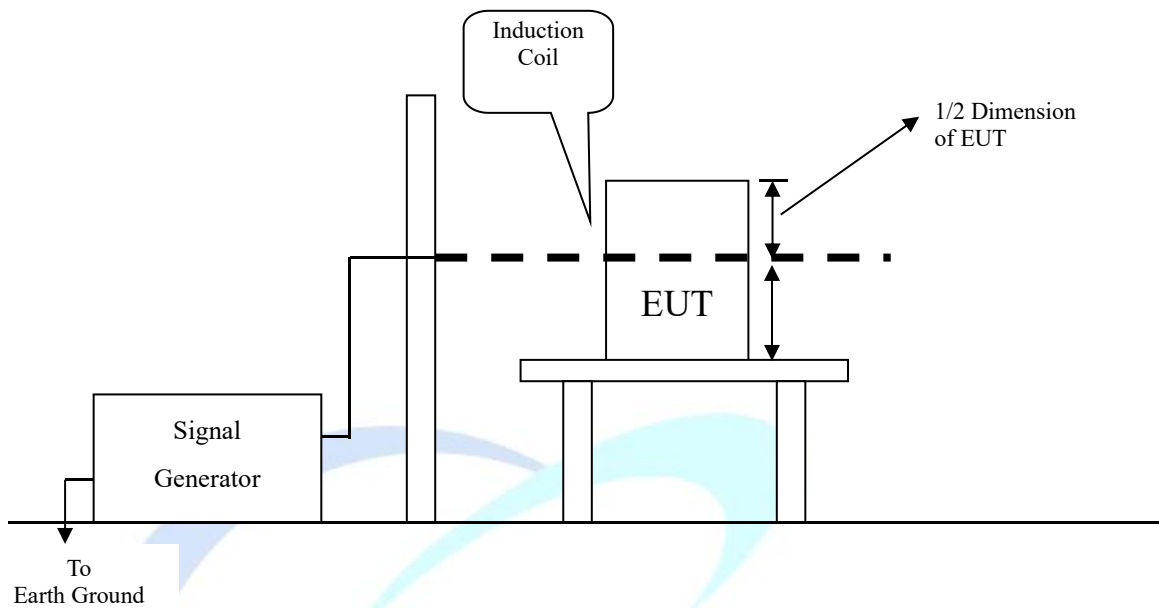

For the actual test configuration, please refer to the related item – Photographs of the Test Configuration
 Note:

TABLETOP EQUIPMENT

The equipment shall be subjected to the test magnetic field by using the induction coil of standard dimension (1 m x 1 m). The induction coil shall then be rotated by 90 degrees in order to expose the EUT to the test field with different orientations.

FLOOR-STANDING EQUIPMENT

The equipment shall be subjected to the test magnetic field by using induction coils of suitable dimensions. The test shall be repeated by moving and shifting the induction coils, in order to test the whole volume of the EUT for each orthogonal direction. The test shall be repeated with the coil shifted to different positions along the side of the EUT, in steps corresponding to 50 % of the shortest side of the coil. The induction coil shall then be rotated by 90 degrees in order to expose the EUT to the test field with different orientations.

8.8.4. TEST RESULT

Product	7kW AC EV Charger	Environmental Conditions	24.1 °C, 54.1 % RH, 101.12 kPa
Model	PAC—CE7002	Tested By	Brian
Test mode	Full Load	Test Result	Pass

Antenna aspect	Duration (min)	Field Strength (A/m)	Observation	Performance Criterion
X	5 min	30	Note <input checked="" type="checkbox"/> 1 <input type="checkbox"/> 2 <input type="checkbox"/> 3	A
Y	5 min	30	Note <input checked="" type="checkbox"/> 1 <input type="checkbox"/> 2 <input type="checkbox"/> 3	A
Z	5 min	30	Note <input checked="" type="checkbox"/> 1 <input type="checkbox"/> 2 <input type="checkbox"/> 3	A

The test only applies to apparatus containing device susceptible to magnetic fields, such as hall elements or magnetic field sensor, so this item isn't applicable to the products.

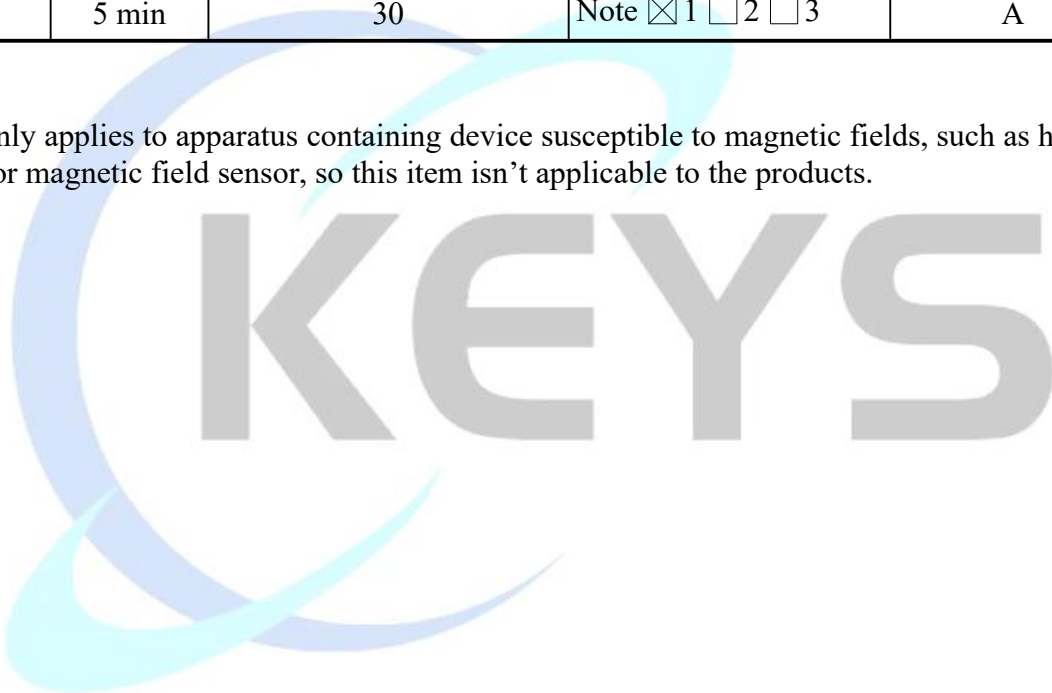

8.9. VOLTAGE DIP & VOLTAGE INTERRUPTIONS

8.9.1. TEST SPECIFICATION

Basic Standard:	IEC 61000-4-11
Test Duration Time:	3 test events in sequence
Interval Between Event:	10 seconds
Phase Angle:	0°
Test Cycle:	3 times
Performance Criterion:	40% U_T 10/ 12 P, Criterion: B 70% U_T 25/ 30 P, Criterion: B 0% U_T / 1 P, Criterion: B 0% U_T 250/ 300 P, Criterion: C

8.9.2. TEST PROCEDURE

The EUT and support units were located on a wooden table, 0.8 m away from ground floor.

Setting the parameter of tests and then perform the test software of test simulator.

Changes to the voltage level shall occur at 0 degree crossing point in the a.c. voltage waveform.

Record the test result in test record form.

8.9.3. TEST SETUP

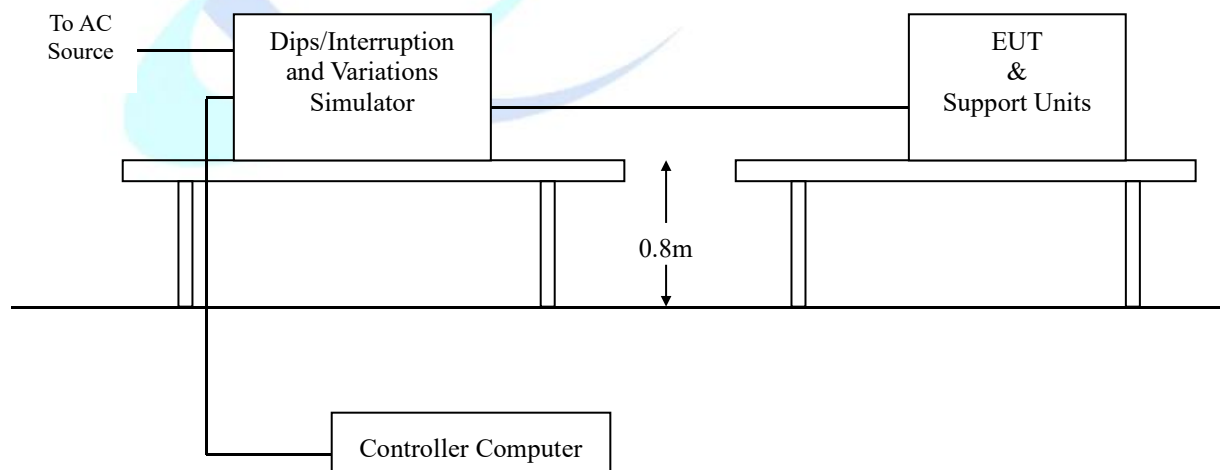

For the actual test configuration, please refer to the related item – Photographs of the Test Configuration.

8.9.4. TEST RESULT

Product	7kW AC EV Charger	Environmental Conditions	24.1 °C, 54.1 % RH, 101.1 kPa
Model	PAC—CE7002	Tested By	Brian
Test mode	Full Load	Test Result	Pass

Test Power: 230 Vac, 50 Hz			
Voltage (% Reduction)	Duration (Period)	Observation	Performance Criterion
100	1 P	Note <input type="checkbox"/> 1 <input checked="" type="checkbox"/> 2 <input type="checkbox"/> 3	B
60	10 P	Note <input type="checkbox"/> 1 <input checked="" type="checkbox"/> 2 <input type="checkbox"/> 3	B
30	25 P	Note <input type="checkbox"/> 1 <input type="checkbox"/> 2 <input checked="" type="checkbox"/> 3	B
100	250 P	Note <input type="checkbox"/> 1 <input type="checkbox"/> 2 <input checked="" type="checkbox"/> 3	C

Note:

- 1) There was no change compared with initial operation during the test.
- 2) During the test, the sound appears to be broken. After the test, the sound can return to its original value within 1 minute.
- 3) During the test, the sound appears to be broken and after the test the sound can return to normal within 30 min.

9. PHOTOGRAPHS OF THE TEST CONFIGURATION CONDUCTED EMISSION TEST



RADIATED EMISSION TEST

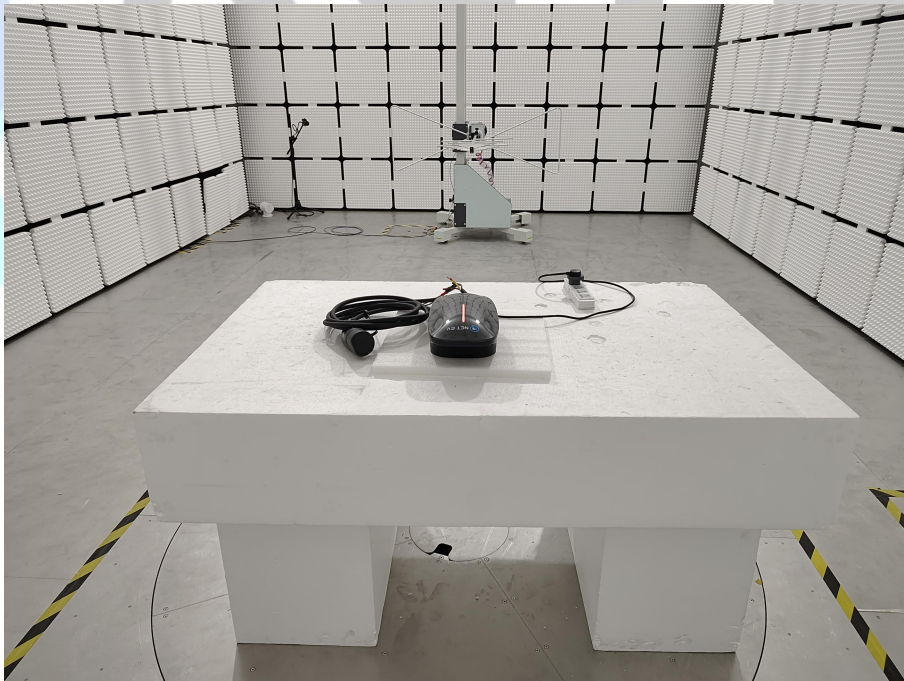

10. PHOTOGRAPHS OF EUT



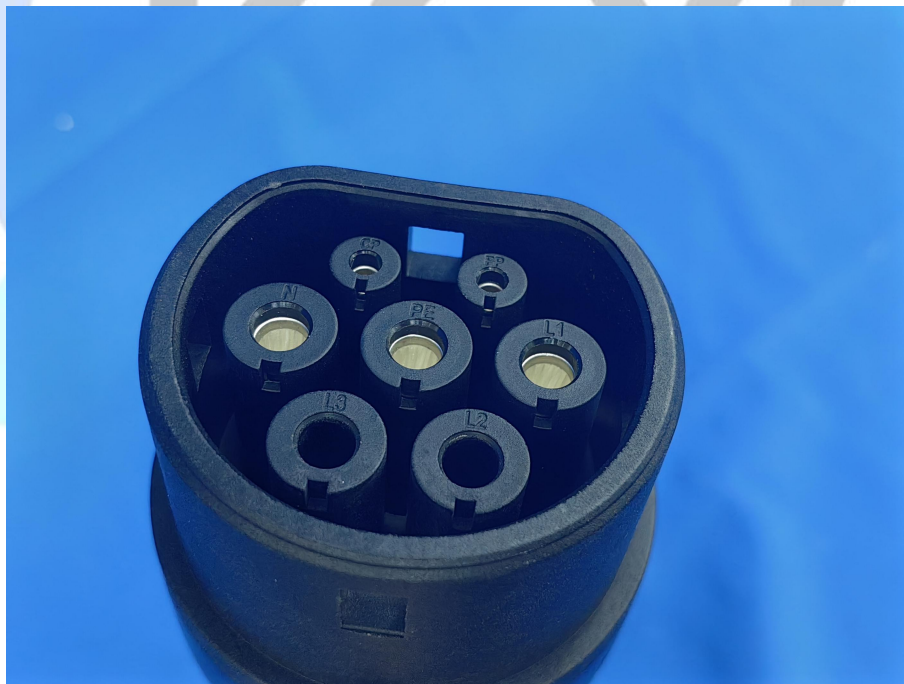

— End of report —